

Report

**Pilot Study Report
Iron and Manganese Removal
Well No. 8 and Well No. 20
Dennis Water District
Dennis, Massachusetts**

Prepared for:

Board of Water Commissioners
Dennis Water District
80 Old Bass River Road
South Dennis, Massachusetts 02660

Prepared by:

Earth Tech, Inc.
923 Route 6A, Unit A
Yarmouth Port, Massachusetts 02675

Earth Tech, Inc.
300 Baker Avenue, Suite 290
Concord, Massachusetts 01742

June 2007

J.N. 99737

**Pilot Study Report
Iron and Manganese Removal
Well No. 8 and Well No. 20
Dennis Water District
Dennis, Massachusetts**

Prepared for:
Board of Water Commissioners
Dennis Water District
80 Old Bass River Road
South Dennis, Massachusetts 02660

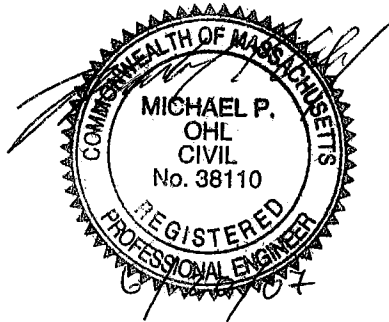

Prepared by:
Earth Tech, Inc.
923 Route 6A, Unit A
Yarmouth Port, Massachusetts 02675

Earth Tech, Inc.
300 Baker Avenue, Suite 290
Concord, Massachusetts 01742

June 2007

J.N. 99737



A **tyco** International Ltd. Company

923 Route 6A
Unit A
Yarmouth Port, MA
02675
P 508.362.2794
P 508.362.3061
F 508.362.3769
www.earthtech.com

300 Baker Avenue
Suite 290
Concord, MA
01742
P 978.371.4000
F 978.371.2468
www.earthtech.com

June 20, 2007

Mr. David Larkowski
Dennis Water District
80 Old Bass River Road
P.O. Box 2000
South Dennis, MA 02660

Subject: Pilot Study Report
Iron and Manganese Removal
Well No. 8 and Well No. 20

Dear Mr. Larkowski:

We are pleased to submit six (6) copies of our Pilot Study Report presenting the findings of the pilot testing of pressure filtration using Hungerford & Terry's GreensandPlus media and Layne Christensen's LayneOx media for the removal of iron and manganese at Well No. 8 and Well No. 20. This report includes our recommendation for which process to utilize in the full-scale water treatment facility design. We have provided a description of the facilities with a proposed floor plan and our opinion of probable construction costs.

We have also transmitted this report to the Massachusetts Department of Environmental Protection Southeast Regional office for their review and approval.

If you have any questions or comments regarding this report, please contact Kristen at 978-371-4099 or Mike at 978-371-4075 at your earliest convenience.

Very truly yours,

Earth Tech, Inc.

Kristen M. Berger, P.E.
Project Engineer

Michael P. Ohl, P.E.
Project Manager

TABLE OF CONTENTS

<u>Section</u>	<u>Page</u>
TABLE OF CONTENTS	i
LIST OF FIGURES	iii
LIST OF TABLES	iv
LIST OF APPENDICES	iv
EXECUTIVE SUMMARY	ES-1
1. INTRODUCTION	1-1
A. OVERVIEW	1-1
B. OBJECTIVE	1-1
2. RAW WATER CHARACTERISTICS	2-1
A. HISTORICAL WATER QUALITY	2-1
B. IRON AND MANGANESE	2-1
3. PILOT TESTING PROGRAM	3-1
A. PILOT TESTING EQUIPMENT AND OPERATION	3-1
1. GreensandPlus System	3-3
2. LayneOx System	3-4
B. PILOT TESTING SAMPLING PROTOCOL	3-5
4. PILOT TESTING EVALUATION	4-1
A. PILOT TESTING OPERATION	4-1
B. FIELD DATA	4-2
1. Iron & Manganese – GreensandPlus System	4-2
2. Iron & Manganese – LayneOx System	4-2
3. pH Adjustment	4-3
4. Differential Pressure	4-4
5. Simulated Raw Water Transmission Main	4-4
6. Pilot Testing Optimum Chemical Dosages	4-6
C. LABORATORY WATER QUALITY DATA	4-7
D. BACKWASH CHARACTERISTICS	4-14
5. SUMMARY AND RECOMMENDATIONS	5-1
A. SUMMARY	5-1
B. PRESSURE FILTER SYSTEM DESIGNS	5-2
1. Vertical and Horizontal Vessels	5-2
2. Full Scale Process Design	5-4
3. Process System Budget Costs	5-5
C. DECISION MATRIX	5-5
D. DESIGN RECOMMENDATIONS	5-6

TABLE OF CONTENTS (Continued)

<u>Section</u>	<u>Page</u>
6. DESCRIPTION OF WATER TREATMENT FACILITIES	6-1
A. TREATMENT PLAN	6-1
B. DESCRIPTION OF FACILITIES	6-3
1. Backwash Supply from On-Site Basin Versus Distribution System.....	6-3
2. Disposal of Backwash Residuals.....	6-4
3. Design Criteria	6-5
C. ESTIMATED CAPITAL AND O&M COSTS.....	6-7

TABLE OF CONTENTS (Continued)

LIST OF FIGURES

<u>Figure No.</u>		<u>Page</u>
3-1	Pilot Process Schematic.....	3-2
3-2	Corrosion Control Facility.....	3-1
3-3	GreensandPlus Pilot Vessel.....	3-3
3-4	LayneOx Pilot Vessel.....	3-5
4-1	Well No. 20 GreensandPlus Pilot, Field Data – Iron.....	4-16
4-2	Well No. 20 LayneOx Pilot, Field Data – Iron.....	4-17
4-3	Well No. 8 GreensandPlus Pilot, Field Data – Iron.....	4-18
4-4	Well No. 8 LayneOx Pilot, Field Data – Iron.....	4-19
4-5	Well No. 20 GreensandPlus Pilot, Field Data – Manganese	4-20
4-6	Well No. 20 LayneOx Pilot, Field Data – Manganese	4-21
4-7	Well No. 8 GreensandPlus Pilot, Field Data – Manganese	4-22
4-8	Well No. 8 LayneOx Pilot, Field Data – Manganese	4-23
4-9	Well No. 20 LayneOx Pilot 8x20 Mesh Media, Field Data – Iron.....	4-24
4-10	Well No. 20 LayneOx Pilot 8x20 Mesh Media, Field Data – Manganese	4-25
4-11	Well No. 20 GreensandPlus Pilot, Filtered Water pH and Iron.....	4-26
4-12	Well No. 20 LayneOx Pilot, Filtered Water pH and Iron.....	4-27
4-13	Well No. 8 GreensandPlus Pilot, Filtered Water pH and Iron.....	4-28
4-14	Well No. 8 LayneOx Pilot, Filtered Water pH and Iron.....	4-29
4-15	Well No. 20 GreensandPlus Pilot, Filtered Water pH and Manganese	4-30
4-16	Well No. 20 LayneOx Pilot, Filtered Water pH and Manganese	4-31
4-17	Well No. 8 GreensandPlus Pilot, Filtered Water pH and Manganese	4-32
4-18	Well No. 8 LayneOx Pilot, Filtered Water pH and Manganese	4-33
4-19	Well No. 20 GreensandPlus Pilot, Differential Pressure.....	4-34
4-20	Well No. 20 LayneOx Pilot, Differential Pressure.....	4-35
4-21	Well No. 8 GreensandPlus Pilot, Differential Pressure.....	4-36
4-22	Well No. 8 LayneOx Pilot, Differential Pressure.....	4-37
4-23	Transmission Main Flush Water	4-5
4-24	Backwash Waste.....	4-14
5-1	Vertical Pressure Filter.....	5-3
5-2	Horizontal Pressure Vessel with 3 Filter Cells.....	5-3
6-1	Proposed Water Treatment Plan.....	6-2
6-2	Proposed Water Treatment Facility Floor Plan.....	6-9

TABLE OF CONTENTS (Continued)

LIST OF TABLES

<u>Table No.</u>		<u>Page</u>
ES-1	Decision Matrix.....	ES-2
ES-2	Opinion of Probable Construction Costs.....	ES-3
ES-3	Estimated Additional Operation and Maintenance Costs.....	ES-4
2-1	Historical Raw Water Quality.....	2-1
3-1	Daily On-Site Testing with Portable Analytical Equipment.....	3-6
3-2	Off-Site Testing for Each Pilot Run at DEP Approved Laboratory.....	3-6
4-1	Pilot Testing Runs.....	4-1
4-2	Pilot Testing Observed pH Ranges.....	4-4
4-3	Pilot Testing Optimum Chemical Dosages.....	4-6
4-4	Raw and GreensandPlus Water Quality Well No. 20.....	4-8
4-5	Raw Water and LayneOx Water Quality Well No. 20.....	4-9
4-6	Raw Water and GreensandPlus Water Quality Well No. 8.....	4-10
4-7	Raw and LayneOx Water Quality Well No. 8.....	4-11
4-8	Water Quality April 13, 2007: Runs No. 4G and No. 4L Well No. 20.....	4-12
4-9	Water Quality April 19, 2007: Runs No. 8G and No. 8L Well No. 8.....	4-13
4-10	GreensandPlus System Backwash Waste Data.....	4-15
4-11	LayneOx System Backwash Waste Data.....	4-15
5-1	Decision Matrix.....	5-6
6-1	Wells to Receive Treatment.....	6-1
6-2	Description of Treatment Facilities.....	6-1
6-3	Opinion of Probable Construction Costs.....	6-7
6-4	Estimated Additional Operation and Maintenance Costs.....	6-8

LIST OF APPENDICES

- A. Manufacturer Equipment Data Sheets
 - 1. Hungerford & Terry, GreensandPlus Media
 - 2. Layne Christensen, LayneOx Media

- B. Field Data and Notes
 - 1. GreensandPlus Pilot
 - 2. LayneOx Pilot

- C. DEP Certified Laboratory Data
 - 1. Well No. 20 Data
 - 2. Well No. 8 Data
 - 3. Backwash Waste Data

- D. Budget Cost Estimate – GreensandPlus Systems

- E. Budget Cost Estimate – LayneOx System

- F. Pilot Report – LayneOx System

EXECUTIVE SUMMARY

During April and May of 2007, Earth Tech Inc. conducted a pilot study examining the effectiveness of potential treatment for iron and manganese removal at several of the Dennis Water District's groundwater supplies. The District has two separate pressure zones (North Side and South Side) with dedicated sources of groundwater supply within each system. Approximately ten of the District's groundwater supply wells, 5 in each pressure zone, require treatment for the removal of iron and manganese. The current intent is to construct two water treatment facilities, one in each pressure zone, which would be dedicated to treating the wells within that zone. As discussed with the Massachusetts Department of Environmental Protection (DEP), for this pilot study water from two groundwater wells were pilot tested separately, Well No. 20 within the North Side and Well No. 8 within the South Side.

Two separate treatment technologies were evaluated on each well during the study; a multimedia pressure filter with Hungerford and Terry's GreensandPlus media (GreensandPlus system) and a pressure filter with Layne Christensen's LayneOx media (LayneOx system). The primary piloting objective was to demonstrate stable system performance while meeting drinking water treatment objectives for select parameters including iron and manganese. This document provides a summary of the operational and analytical results obtained from the pilot study, which are then used to establish the design parameters for the proposed treatment facilities.

Once optimized, both pilot systems were able to produce their respective water quality treatment objectives by consistently producing finished water with levels less than the SMCLs of 0.3 mg/L of iron (Fe) and 0.05 mg/L of manganese (Mn). However, the GreensandPlus system was able to consistently produced water with better quality over that produced by the LayneOx system.

During the extended filter runs the GreensandPlus system produced approximately 15% more water than the LayneOx system during the extended run at Well No. 20 and the GreensandPlus system produced approximately 34% more water than the LayneOx system during the extended run at Well No. 8. Using the pilot data to estimate filter run times of 96 hours for the GreensandPlus system and 48 hours for the LayneOx system, we calculated the process efficiencies. The GreensandPlus system is 0.37% more efficient than the LayneOx system. This translates to a savings of 10.8 million gallons per year in backwash supply water (assumes operation at 4 mgd non-stop for two facilities).

In addition to water quality and process efficiency, we examined cost components. The GreensandPlus media can be utilized by several manufacturers of pressure filter systems which allows for more competitive bid prices. The LayneOx media is proprietary and can only be used with the pressure filter system manufactured by Layne Christensen Co. While the higher hydraulic loading rate provided by the LayneOx system allows for a slightly smaller building footprint, the difference in footprint is relatively small and does not significantly impact the overall capital cost of the facility. Additionally the capital cost for the LayneOx system is more than that for the GreensandPlus system.

The following decision matrix presents the factors involved in the selection process. Each factor was rated as 1 = Poor or 2 = Good. The factors were weighted as shown. The Relative Score is the Sum of the Factor Ratings times the Factor Weight. The decision matrix shows that the GreensandPlus system is slightly more favorable than the LayneOx system. We have weighted the factors according to the level of importance we feel should be placed on each.

**TABLE ES-1
DECISION MATRIX**

1 = Poor, 2 = Good

Factor	Factor Weight	GreensandPlus System	LayneOx System
Filtered water meets drinking water standards	10%	2	2
System excels in removing Fe & Mn	10%	2	1
Volume of water treated between backwashes	10%	2	1
Volume of water produced annually	10%	2	1
Higher hydraulic loading rate (smaller footprint)	10%	1	2
Ease of operation and training of staff	10%	2	2
Competitive bidding environment	10%	2	1
Facility capital costs (process & building)	15%	2	2
Operation and maintenance costs	15%	2	2
Relative Score	100%	1.9	1.6

After consideration of all of the factors above, we recommend that the District utilize the GreensandPlus system as the primary treatment process for the removal of iron and manganese at the proposed water treatment facilities.

Some of the pilot testing was performed with a simulated raw water transmission main to mimic chemical addition at the existing corrosion control facilities. The additional detention time allowed for removal of iron and manganese that met or exceeded removals achieved without the transmission main. The field

data show that utilizing the District's existing corrosion control facilities for addition of chemicals for pH adjustment and oxidation is feasible for final design. This design provides for additional cost savings since the District will be able to continue to utilize an investment in which they have already made and they will not have to build space for pre-filter chemical feed systems at the new facilities.

The proposed GreensandPlus water treatment facilities will have the design parameters listed in Section 6 of this report. The current intent is to have two facilities, one for each pressure zone. Each facility will be designed for 2,850 gallons per minute (gpm) or approximately 4 million gallons per day (mgd) with six vertical filter vessels 11-feet in diameter. The buildings will be slab-on-grade, pre-engineered metal buildings with standing seam metal roofs approximately 45 feet by 85 feet (3,825 square feet) each. Each facility will have unique site designs and will be equipped with on-site lagoons for residuals handling.

Our estimates of probable project cost are for planning purposes only and should be re-evaluated prior to appropriating funds for the actual construction of each project. The engineering, construction and operational cost are based on individual site-specific projects. The ENR construction cost index at the time of this budget cost estimate was 7939 for June 2007. The opinion of probable construction costs are shown in the following Table ES-2.

**TABLE ES-2
OPINION OF PROBABLE CONSTRUCTION COSTS**

Item	Description	Cost
North Side WTP	WTP Construction	\$ 3,500,000
	Water Main Construction	\$ 900,000
	Subtotal - Construction	\$ 4,400,000
South Side WTP	WTP Construction	\$ 3,500,000
	Water Main Construction	\$ 1,100,000
	Subtotal - Construction	\$ 4,600,000
Contingency	20% of Construction Estimate	\$ 1,800,000
Engineering	Design/Bidding/Construction	\$ 1,100,000
Total		\$ 11,900,000

Assumptions:

Land already owned by District - no land acquisition costs included.

Water main costs assume public bidding is not required and construction is by the District.

Costs projected to 2008, assuming 3% inflation rate.

Table ES-3 shows the estimated additional operation and maintenance costs.

TABLE ES-3
ESTIMATED ADDITIONAL OPERATION AND MAINTENANCE COSTS

Description	Cost	Frequency
Labor (1 operator)	\$80,000	per year
Electricity (\$0.22 per kwh)	\$180,000	per year
Chemicals	\$50,000	per year
Media Replacement	\$200,000	every 10 years

Assumptions:

Costs shown are additional to those the District already experiences.

Costs for 16 hours per day operation at 4 mgd.

Costs based on two water treatment facilities.

Labor cost includes fringe benefits.

Chemical costs for sodium hypochlorite only.

Media cost is materials only (no labor or disposal costs).

SECTION 1
Introduction

1. INTRODUCTION

A. OVERVIEW

Several of the District's groundwater supplies have elevated concentrations of iron and/or manganese, above the U.S. Environmental Protection Agency (USEPA) Secondary Maximum Contaminant Level (SMCL). This pilot study is a continuation of the Iron and Manganese Treatment Feasibility Study, dated February 19, 2007, performed by Earth Tech, Inc. The current intent is to construct two water treatment facilities, one in each pressure zone, which will ultimately treat water from ten of the District's wells.

As discussed with the Massachusetts Department of Environmental Protection (DEP) Southeast Region, piloting was conducted on one well within each zone, preferably a well that had historically shown higher levels of iron and manganese. For the North Side, the well with the highest levels of iron and manganese has been Well No. 11. However, this well was being cleaned and redeveloped as part of routine maintenance and was not available during the pilot study. As an alternate, Well No. 20 was used for the North Side pilot study, as it had historically shown high levels of iron and manganese. Recent sampling of Well No. 20 by the District (first quarter of 2007) indicated iron levels of approximately 1.1 mg/L. For the South Side, Well No. 8 was tested since historically it has shown the worst water quality in this zone. Well No. 20 was selected to demonstrate the processes abilities to treat water with higher iron levels, while Well No. 8 was selected to demonstrate the processes abilities to treat water with higher manganese levels.

The processes tested during this pilot study were a multimedia pressure filter with Hungerford and Terry, Inc.'s GreensandPlus media (GreensandPlus system) and a pressure filter with Layne Christensen Company's LayneOx media (LayneOx system). Earth Tech, Inc. operated the GreensandPlus system from April 9 through May 4, 2007. Operators from Layne Christensen Company operated the LayneOx system from April 9 through May 2, 2007 and May 15 through May 18, 2007.

B. OBJECTIVE

The pilot testing objectives were to determine the adequacy and capability of the processes to treat groundwater from Well No. 20 and Well No. 8. Operational parameters affecting full-scale treatment design were determined by evaluation of the following parameters:

- Treated water quality
 - Total Iron concentration in the filtered water (Goal: below 0.3 mg/L)
 - Total Manganese concentration in the filtered water (Goal below 0.05 mg/L)
- Hydraulic loading rates
- Operating run lengths
- Chemical feed requirements
- Waste characteristics

SECTION 2

Raw Water Characteristics

2. RAW WATER CHARACTERISTICS

A. HISTORICAL WATER QUALITY

As shown in Table 2-1 the historical raw water quality of the groundwater well supply sources with elevated concentrations of iron (Fe) and/or manganese (Mn). The full-scale system would treat water from a combination of wells or individually from each well.

**TABLE 2-1
HISTORICAL RAW WATER QUALITY**

Well No.	Flow (gpm)	Iron			Manganese			pH**	Alkalinity (mg/L as CaCO ₃)**
		2005 Fe (mg/L)	Historical Average (mg/L)*	Historical Maximum (mg/L)*	2005 Mn (mg/L)	Historical Average (mg/L)*	Historical Maximum (mg/L)*		
North Side									
4	300	0.8	0.67	1.7	0.02	0.05	0.1	5.6	4.38
9	600	0.2	0.13	0.3	0.03	0.05	0.07	5.4	1.50
11	500	1.2	0.75	1.8	0.07	0.10	0.17	5.56	5.13
19	700	0.4	0.22	0.6	0.04	0.04	0.07	7.08	29.1
20	700	0.47	0.60	1.3	0.04	0.04	0.11	6.01	8.88
South Side									
7	450	0.1	0.09	0.1	0.08	0.09	0.14	5.81	3.25
8	300	0.5	0.35	0.7	0.26	0.25	0.40	5.59	2.88
15	700	0.33	0.21	0.4	0.05	0.06	0.19	7.06	32.9
16	450	0.1	0.12	0.3	0.15	0.22	0.30	6.99	60.1
21	700	0.36	0.25	0.4	0.10	0.10	0.10	5.27	6.33

*Wells No. 4 through No. 19: average and maximum data over 14 years. Well No. 20: average and maximum data over 8 years. Well No. 21: average and maximum data over 2 years.

**Wells No. 4 through No. 20: average data over 8 years. Well No. 21: average data over 2 years.

B. IRON AND MANGANESE

Iron (Fe) and Manganese (Mn) are minerals in drinking water which when present at elevated levels cause aesthetic and nuisance issues as follows:

- Stain laundry and water use fixtures
- Cause metallic or vinyl type taste in the water
- Clog household water filters
- Cause objectionable water color
- Prompt customer complaints
- Support growth of Fe/Mn bacteria, non-health related bacteria that clog strainers/pumps/valves
- May increase the number of coliform "hits" in the distribution system

The Environmental Protection Agency (EPA) and MA DEP regulate iron and manganese in drinking water as Secondary Maximum Contaminant Levels (SMCLs) to protect public welfare and promote increased customer satisfaction. The SMCL for Fe is 0.3 mg/L and Mn is 0.05 mg/L. Levels above SMCLs lead to loss of customer confidence in water quality/health, resulting in customers seeking alternate supplies. Compliance with SMCLs is strongly encouraged by the MA DEP.

The District noticed an increasing problem with Fe and Mn after implementation of their corrosion control program. Using potassium hydroxide (KOH), the District raises the pH of the groundwater to approximately 7.2 pH units. Fe and Mn precipitate more readily at this pH. However, the increase in pH is required to be in compliance with the Lead and Copper Rule, as the District has attempted to reduce the pH recently in order to minimize the Fe and Mn problems, but could not maintain this lower pH and maintain compliance with the Lead and Copper Rule.

In past years, the District has attempted to control the precipitation of Fe and Mn from the water in the distribution system through dosing of sequestering chemicals such as sodium hexametaphosphate. However, the levels of Fe and Mn have become unmanageable using the existing mitigation methods. Additionally, historical data show that a trend of increasing Fe and Mn levels in some wells.

Fe and Mn removal is the final method of mitigation and this is achieved using a water treatment facility. After review of the data, the District determined that the preferred treatment alternative for Fe and Mn removal would be two water treatment facilities, one for each zone, and both facilities would utilize pressure filtration.

SECTION 3

Pilot Testing Program

3. PILOT TESTING PROGRAM

A. PILOT TESTING EQUIPMENT AND OPERATION

Two iron and manganese removal processes were tested for this study. The first is a pressure filtration system utilizing GreensandPlus media by Hungerford and Terry and the second is a pressure filtration system utilizing granular oxidative media called LayneOx by Layne Christensen Company. These removal processes were selected because each has a proven success at full scale for the removal of iron and manganese from groundwater supply sources. Figure 3-1 (see next page) shows a process schematic for the two pilots. Each pilot process is described in detail below.

At Well No. 20 water was taken from the discharge of the well pump for the first phase of testing and from the 100 foot sample line located downstream of the corrosion control facility for the second phase of testing. At Well No. 8 water was taken from the 100 foot sample line located downstream of the corrosion control facility for all tests. The pH of the water was adjusted prior to entering the filter.





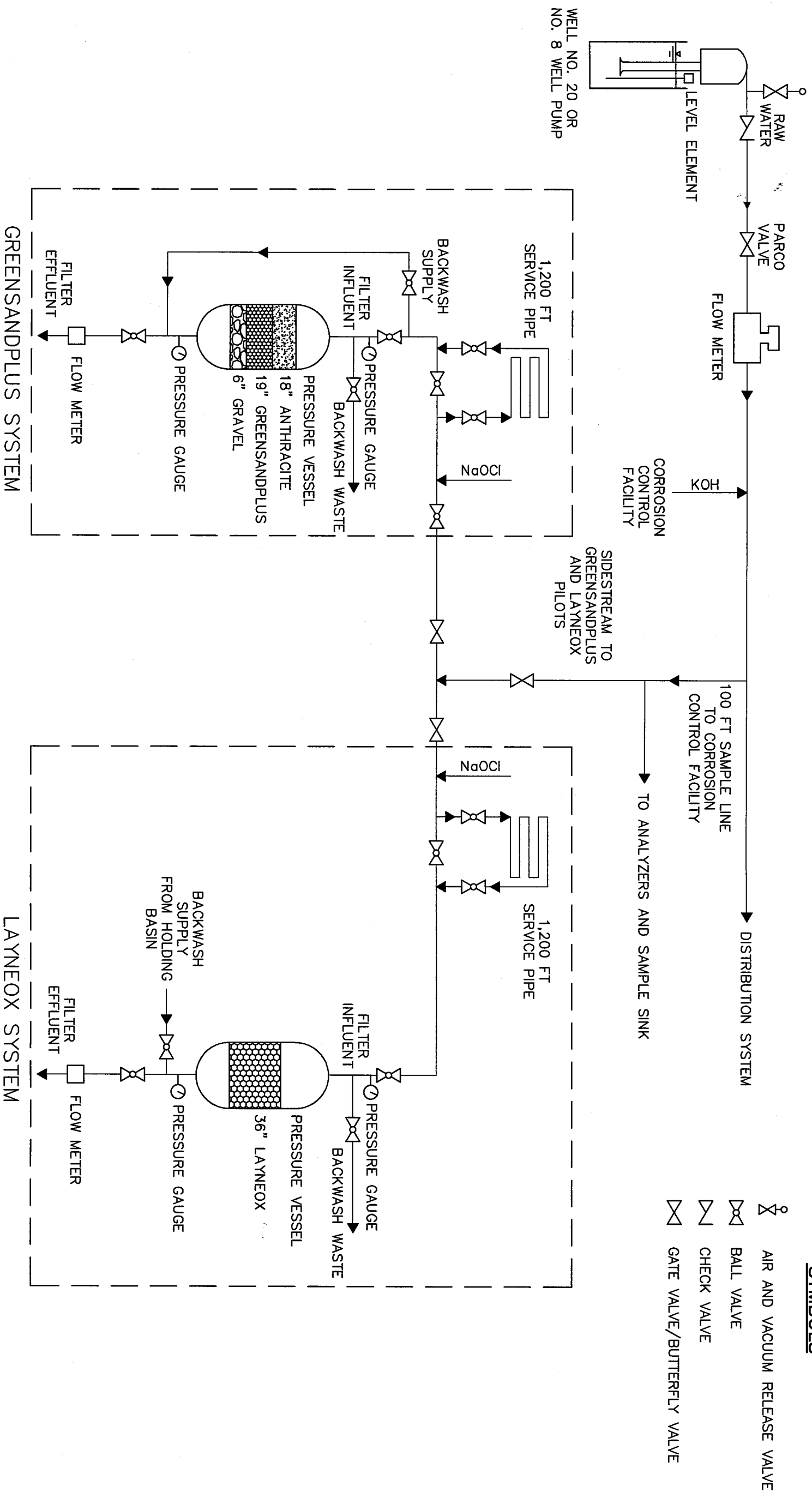

**FIGURE 3-2
CORROSION CONTROL FACILITY**

During test phase 1 at Well No. 20, the pH of the water was using potassium hydroxide (KOH) dosed and controlled by the individual pilot operators. During phase 2 testing at Well No. 20 and testing at Well No. 8, water was pH adjusted at the corrosion control facilities by the District and then taken from the 100 foot sample water line, which provided water of the same pH to each pilot unit.

The intent, for full-scale treatment, is to inject KOH and sodium hypochlorite (NaOCl) at the existing corrosion control facilities. The chemically adjusted water would flow through transmission mains to the water treatment facilities. This design allows the District to utilize the existing chemical feed systems and to customize chemical dosing to each well. The transmission main design was simulated during the pilot study through the use of 1,200 feet of 1-inch service pipe installed downstream of the chemical injection ports but upstream of the filter vessels.



SYMBOLS

-  AIR AND VACUUM RELEASE VALVE
-  BALL VALVE
-  CHECK VALVE
-  GATE VALVE/BUTTERFLY VALVE

1. GreensandPlus System

The pilot study evaluated the effectiveness of Hungerford and Terry's GreensandPlus media on the removal of iron (Fe) and manganese (Mn) from groundwater supply sources located at Wells No. 8 and No. 20. GreensandPlus is a silica sand core media coated with manganese dioxide (MnO_2). The GreensandPlus media was contained within a closed, pressure type vessel with a surface area of approximately 0.5 square feet (sf). The filter vessel contained 18-inches of anthracite over 19-inches of GreensandPlus media supported by 6-inches of gravel. The 18x60 mesh GreensandPlus media has an effective size of 0.3 to 0.35 millimeters (mm). Sodium hypochlorite was used for oxidation prior to filtration through the GreensandPlus pressure filter vessel. A picture of the pilot unit is shown in Figure 3-3. A data sheet describing the GreensandPlus media is provided in Appendix A.

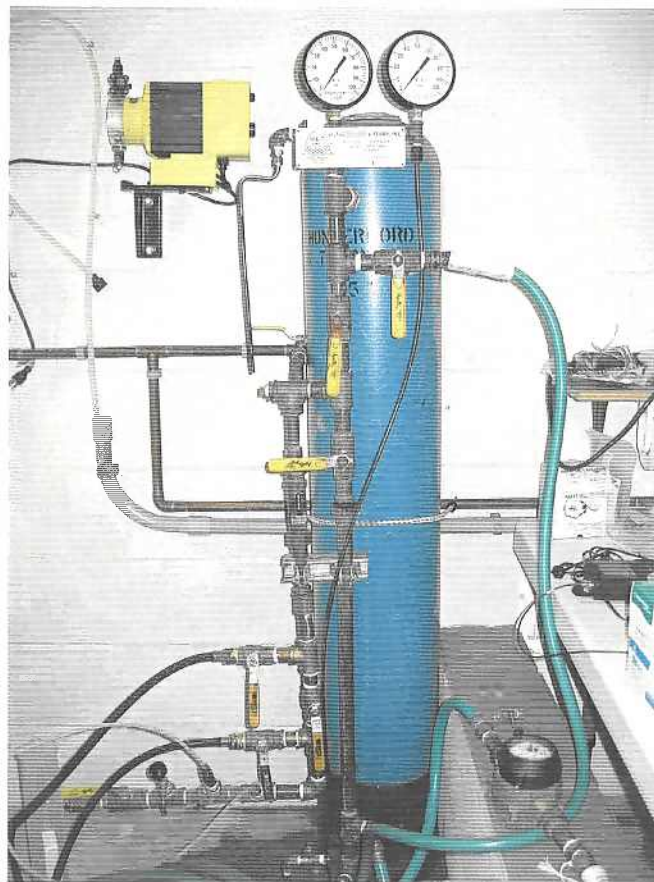

**FIGURE 3-3
GREENSANDPLUS PILOT VESSEL**

The GreensandPlus filtration pilot was operated in continuous regeneration (CR) mode during which most of the soluble iron and manganese were oxidized before entering the greensand filter. This was accomplished by the continual pre-feed of sodium hypochlorite. The oxidized precipitates were then filtered by the media with subsequent removal during backwashing. The filter bed was capped with anthracite coal to remove the majority of the precipitates so as not to blind the GreensandPlus media.

The GreensandPlus filter pilot unit loading rates tested were from 4 gallons per minute per square foot (gpm/sf) and 6 gpm/sf. The unit was backwashed at the end of each run which was determined based on time or water quality breakthrough. Pressure differential did not dictate backwash during this study. The maximum recommended pressure differential for this media is 8 to 10 pounds per square foot (psi). The filter media was typically backwashed at 10 gpm/sf for 10 minutes.

2. LayneOx System

The LayneOx process utilizes granular oxidative media to remove iron and manganese from water supplies. Sodium hypochlorite was used for oxidation prior to filtration through the LayneOx pressure filter vessel. The LayneOx process has manganese dioxide (MnO_2) present on the media, which provides additional iron and manganese oxidation from the water and adsorption to the media. As the process continues the differential pressure across the media bed increases and requires backwashing. The LayneOx media was contained within a closed, pressure type vessel with a surface area of approximately 0.785 sf. Most of the pilot was operated with the 20x40 mesh media with an effective size of 0.3 to 0.5 mm. One run was completed with the 8x20 mesh media with an effective size of 1 to 1.3 mm. A data sheet describing the LayneOx media is provided in Appendix A.

The LayneOx filter pilot unit loading rates were 6, 8 and 10 gpm/sf. The media was backwashed based on time, breakthrough of water quality or differential pressure. The manufacturer recommended maximum pressure differential of 10 psi, was reached during some of the pilot runs. The 20x40 mesh media was typically backwashed at 25 gpm/sf for 5 minutes and the 8x20 mesh media was backwashed at 30 gpm/sf for 5 minutes.



**FIGURE 3-4
LAYNEOX PILOT VESSEL**

B. PILOT TESTING SAMPLING PROTOCOL

The pilot system operator manually sampled and analyzed for select parameters on site during each pilot run as shown in Table 3-1. The on-site daily testing was performed using a HACH portable colorimeter. The table lists the analytical methods used to complete the tests. A DEP certified laboratory, Groundwater Analytical, Inc., Buzzards Bay, Massachusetts performed all outside analytical services shown in Table 3-2.

**TABLE 3-1
DAILY ON-SITE TESTING WITH
PORTABLE ANALYTICAL EQUIPMENT**

Parameter	Analytical Method	Detection Limit
Total Iron	FerroVer® Method 8008 – Powder Pillows	0.022 mg/L Fe
Total Manganese	PAN Method 8149 – Powder Pillows	0.007 mg/L Mn
Free Chlorine	DPD Method 8021 – Powder Pillows	0.02 mg/L Cl ₂
pH	Orion pH probe	--
Temperature	Thermometer	--

**TABLE 3-2
OFF-SITE TESTING FOR EACH PILOT RUN
AT DEP APPROVED LABORATORY**

Parameter	Raw Water	Greensand Filter Effluent	LayneOx Filter Effluent
During Operation			
pH	Daily	Daily	Daily
Alkalinity	Daily	Daily	Daily
Total Manganese	Daily	Daily	Daily
Dissolved Manganese	Daily	Daily	Daily
Total Iron	Daily	Daily	Daily
Dissolved Iron	Daily	Daily	Daily
Turbidity	One Per Well	One Per Well	One Per Well
CO ₂	One Per Well	One Per Well	One Per Well
Color (apparent)	One Per Well	One Per Well	One Per Well
Color (true)	One Per Well	One Per Well	One Per Well
Hardness	One Per Well	One Per Well	One Per Well
Calcium	One Per Well	One Per Well	One Per Well
Sodium	One Per Well	One Per Well	One Per Well
Magnesium	One Per Well	One Per Well	One Per Well
Potassium	One Per Well	One Per Well	One Per Well
Sulfates	One Per Well	One Per Well	One Per Well
Nitrates	One Per Well	One Per Well	One Per Well
Inorganics	One Per Well	One Per Well	One Per Well
Total Coliform	One Per Well	One Per Well	One Per Well
Volatile Organic Carbon (VOC)	One Per Well	One Per Well	One Per Well
Filter Backwash			
Total Manganese	--	One Per Well	One Per Well
Total Iron	--	One Per Well	One Per Well
Settleable Solids	--	One Per Well	One Per Well
Total Suspended Solids	--	One Per Well	One Per Well

SECTION 4

Pilot Testing Evaluation

4. PILOT TESTING EVALUATION

A. PILOT TESTING OPERATION

Pilot testing occurred during April and May, 2007. Earth Tech, Inc. operated the GreensandPlus system from April 9 through May 4, 2007. Operators from Layne Christensen Company operated the LayneOx system from April 9 through May 2, 2007 and May 15 through May 18, 2007. The operations of the pilot processes are categorized by process runs. A process run is the period of time elapsed between initiation of filtration and backwashing of the filter. The process runs for this study were terminated based on elapsed time, water quality breakthrough or differential pressure across the filter. Table 4-1 summarizes the pilot testing runs. Tables showing field data and notes recorded during the pilot are included in Appendix B.

**TABLE 4-1
PILOT TESTING RUNS**

Run No.	Date	Location	Trans. Main Used?	Loading Rate (gpm/sf)	Run Duration (hours)	Terminal Differential Pressure (psi)	Volume of Water Treated (gal/sf)
Well No. 20 - GreensandPlus							
Run No. 1G	April 9-10	P.S.	No	4	17.5	3	4,220
Run No. 2G	April 10-11	P.S.	No	4	19.5	2	4,660
Run No. 3G	April 11-12	P.S.	Yes	4	24	0.5	5,820
Run No. 4G	April 12-14	P.S.	Yes	4	48	1	11,500
Run No. 5G	April 30-May 4	C.C.F.	No	6	95	6	34,200
Well No. 20 - LayneOx							
Run No. 1L	April 9-10	P.S.	No	6	24	4.8	8,500
Run No. 2L	April 10-11	P.S.	No	6	24	6.6	8,410
Run No. 3L	April 11-12	P.S.	No	8	24	9.2	11,640
Run No. 4L	April 12-14	P.S.	Yes	8	46	7.25	22,030
Run No. 5L	April 30-May 2	C.C.F.	No	10	49	16.2	29,210
Run No. 9L*	May 15-18	C.C.F.	No	10	50	11.7	30,000
Well No. 8 - GreensandPlus							
Run No. 6G	April 16-17	C.C.F.	No	4	24	0.3	5,860
Run No. 7G	April 17-18	C.C.F.	Yes	4	24	0.2	5,680
Run No. 8G	April 18-23	C.C.F.	Yes	6	116	2.3	41,760
Well No. 8 - LayneOx							
Run No. 6G	April 16-17	C.C.F.	Yes	6	23	3.5	8,800
Run No. 7G	April 17-18	C.C.F.	Yes	6	24	2.5	8,800
Run No. 8G	April 18-20	C.C.F.	No	8	48.5	10	27,430

P.S. = Pump Station

C.C.F. = Corrosion Control Facility

gpm/sf = gallons per minute per square foot

psi = pounds per square foot

gal/sf = gallons per square foot

*Run No. 9L was completed with LayneOx 8x20 mesh media.

B. FIELD DATA

Field and laboratory water quality sampling and analysis were performed during the pilot study. Operational field data was collected for pressure differential, flow rate, pump settings and observation notes. Tables showing the field data and notes are presented in Appendix B. Figure No. 4-1 through Figure No. 4-10, presented at the end of this Section, show the field data for Fe and Mn in the raw and filtered water.

1. Iron & Manganese - GreensandPlus System

The filtered water Fe and Mn levels were below the SMCLs during all runs at each well site. At Well No. 20, 87% to 100% of the Fe was removed (Refer to Figure No. 4-5) and 65% to 100% of the Mn was removed (Refer to Figure No. 4-6). Over 95% of the Fe in the raw water was removed by the GreensandPlus system on 75% of the samples taken. Over 95% of the Mn in the raw water was removed by the GreensandPlus system on 65% of the samples taken. At Well No. 8, 67% to 100% of the Fe was removed (Refer to Figure No. 4-7) and 81% to 100% of the Mn was removed (Refer to Figure No. 4-8). Over 95% of the Fe in the raw water was removed by the GreensandPlus system on 60% of the samples taken. Over 95% of the Fe in the raw water was removed by the GreensandPlus system on 62% of the samples taken.

The filtered water quality remained very stable over the runs completed. Toward the end of the longer run at Well No. 20 (Run No. 5G) the Fe and Mn levels in the filtered water started to increase but were still below 0.1 and 0.01 mg/L respectively after 95 hours. Toward the end of the longer run at Well No. 8 (Run No. 8G) the Fe and Mn levels in the filtered water started to increase but were still below 0.1 and 0.025 mg/L respectively after 116 hours.

2. Iron & Manganese - LayneOx System

The filtered water Fe and Mn levels were below the SMCLs during most runs at each well site. At Well No. 20, 18% to 100% of the Fe was removed (Refer to Figure No. 4-9) and 46% to 100% of the Mn was removed (Refer to Figure No. 4-10). Over 95% of the Fe in the raw water was removed by the LayneOx system on 44% of the samples taken. Over 95% of the Mn in the raw water was removed by the LayneOx system on 42% of the samples taken. At Well No. 8, 71% to 100% of the Fe was removed (Refer to Figure No. 4-11) and 87% to 100% of the Mn was removed (Refer to Figure No. 4-12). Over

95% of the Fe in the raw water was removed by the LayneOx system on 38% of the samples taken. Over 95% of the Fe in the raw water was removed by the LayneOx system on 69% of the samples taken.

For the LayneOx system, the filtered water quality tended to deteriorate over time, with iron and manganese levels increasing steadily over the runs completed. Toward the end of the longer run at Well No. 20 (Run No. 5L) the Fe and Mn levels in the filtered water had increased noticeably but were still below 0.3 and 0.01 mg/L respectively after 49 hours. Toward the end of the longer run at Well No. 8 (Run No. 8L) the Fe and Mn levels in the filtered water had increased but were still below 0.1 and 0.020 mg/L respectively after 48.5 hours.

One run was completed at Well No. 20 using the LayneOx media with 8x20 mesh size, which is a larger grain media than that used for most of the pilot testing. This run was operated at 10 gpm/sf for about 50 hours. The iron and manganese removal percentages were generally not as good as with the smaller media. The iron removal percentages ranged from 46% to 95% with only two readings meeting 95% removal. The manganese removal percentages ranged from 67% to 93%. By the end of the run the iron level had increased to 0.3 mg/L in the filtered water. Figures 4-9 and 4-10 show the levels of iron and manganese over the duration of the run.

3. pH Adjustment

The District raises the pH in the water discharging from the wells to comply with standard Corrosion Control practices. During most the pilot testing, the influent pH was adjusted using KOH. The goal was to raise the pH close to the current adjusted pH of 7.2 while maintaining optimum water quality in the filter effluent. The pH of the water is a major factor affecting optimum oxidation of Fe and Mn from water. For the GreensandPlus system, the manufacturer's recommended pH range is 6.8 to 7.0. For the LayneOx system the manufacturer's recommended pH range is 6.2 to 6.5. Table 4-2 shows the pH ranges and corresponding iron and/or manganese removal observed during the pilot. Figures 4-11 through 4-18, presented at the end of this Section, show the filtered water pH and iron/manganese levels. The figures show that good removal of iron and manganese was achieved at pH 7.0.

**TABLE 4-2
PILOT TESTING OBSERVED pH RANGES**

Well	Average Adjusted pH (Min-Max)	
	GreensandPlus	LayneOx
Well No. 20	7.0 (6.75-7.3)	6.5 (6.0-7.0)
Well No. 8	7.0 (6.9-7.3)	7.0 (6.9-7.2)

4. Differential Pressure

Figures 4-19 through 4-22, presented at the end of this Section, show the differential pressure over time for the long duration runs: Runs 5G, 5L, 8G and 8L.

For the GreensandPlus system, the recommended terminal differential pressure of 8 psi was not reached by the end of the extended runs. Each of the extended runs at both well sites, was terminated based on a slight increase in filtered water iron and/or manganese levels. The iron and manganese levels at the end of Run 5G for Well No. 20 were 0.06 and 0.01 mg/L respectively and at the end of Run 8G for Well No. 8 were 0.05 and 0.01 mg/L respectively. The data show that runs exceeding 4 days are feasible for the GreensandPlus system operated at a hydraulic loading rate of 6 gpm/sf.

For the LayneOx system, the recommended terminal differential pressure of 10 psi was exceeded on Run 5L and met on Run 8L. The iron and manganese levels at the end of Run 5L for Well No. 20 were 0.29 and less than 0.007 mg/L respectively and at the end of Run 8L for Well No. 8 were 0.03 and less than 0.007 mg/L respectively. The data show that runs of approximately 2 days are feasible for the LayneOx system operated at 8 and/or 10 gpm/sf, although iron and manganese levels may reach the SMCL at the end of the 2 day run.

5. Simulated Raw Water Transmission Main

Several of the runs were completed utilizing 1,200 feet of service piping to simulate a transmission main from the District's corrosion control facilities to the proposed treatment facilities. This was done in order to observe the effects of extending the detention time after addition of chemicals for pH adjustment and oxidation. Table 4-1 lists the runs completed with the simulated transmission main. For these runs, excellent removals of iron and manganese were achieved. The additional detention time allowed

for removal of iron and manganese that met or exceeded removals achieved without the transmission main. The field data show that utilizing the District's existing corrosion control facilities for addition of chemicals for pH adjustment and oxidation is feasible for final design. This concept provides for the following advantages:

- utilizes equipment in which the District has already made an investment;
- provides operational flexibility in terms of optimum chemical dosing for different water qualities at each well site;
- improves detention times for the oxidation process;
- provides capital cost savings for the construction of the water treatment facilities.

The simulated transmission main was flushed after each test run to observe the water quality within the main. The flushed water was high in iron content, similar to that observed during current flushing of the distribution system, and did not readily settle out. The full scale system will need to have an operating plan for flushing of the transmission main periodically to remove any iron buildup. The following Figure 4-23 shows the color of the water flushed from the simulated transmission main.

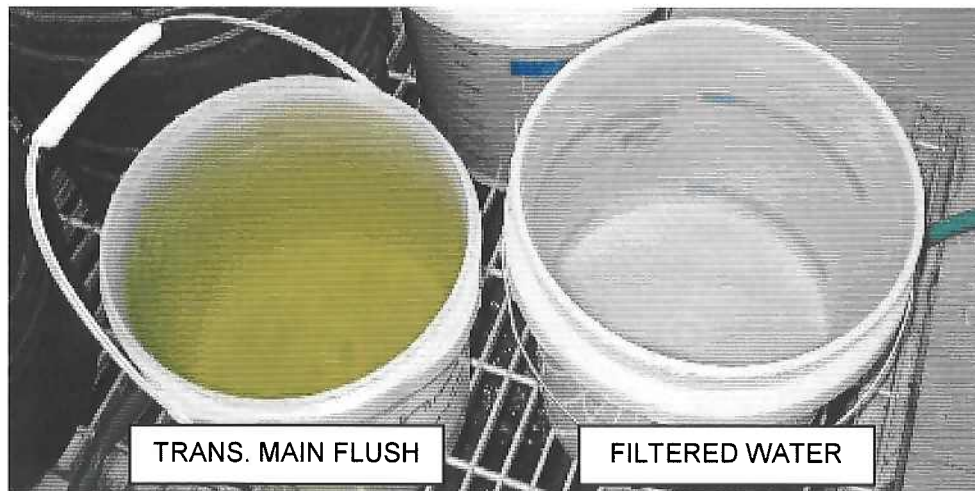

FIGURE 4-23
TRANSMISSION MAIN FLUSH WATER

6. Pilot Testing Optimum Chemical Dosages

The chemicals added during the operation of each pilot were potassium hydroxide (KOH) for pH adjustment and sodium hypochlorite (NaOCl) for metal oxidation. The theoretical doses of NaOCl needed for iron (Fe) and manganese (Mn) oxidation are:

- 0.64 mg NaOCl per mg Fe
- 1.30 mg NaOCl per mg Mn

The NaOCl dose is typically based on the level of Fe in the raw water and the chlorine demand of the oxide-coated media, with a goal to carry 0.5 mg/L residual chlorine in the filter effluent. NaOCl will oxidize the Fe more readily than the Mn. Any Mn not oxidized by the NaOCl will be removed by the oxide-coated media in the filter vessel.

The KOH dose is dependent on many factors. For this pilot test the primary factors affecting the KOH dose needed to raise the pH to an optimum range for oxidation were raw water pH, alkalinity, and temperature.

The optimum chemical dosages observed during the pilot testing are shown in Table 4-3. The information observed during pilot testing will be used in sizing the chemical doses needed for each well site to receive treatment.

**TABLE 4-3
PILOT TESTING OPTIMUM CHEMICAL DOSAGES**

	Well No. 20		Well No. 8	
	GreensandPlus	LayneOx	GreensandPlus	LayneOx
NaOCl dose	1.1 to 1.4 mg/L	1.1 to 1.4 mg/L	0.9 to 1.1 mg/L	0.9 to 1.1 mg/L
Filtered free Cl ₂ residual	0.2 to 0.5 mg/L	0.2 to 0.5 mg/L	0.2 to 0.5 mg/L	0.2 to 0.5 mg/L
KOH dose	32 to 36 mg/L	32 to 36 mg/L	33 mg/L	33 mg/L
Optimum pH range	6.8 to 7.0	6.8 to 7.0	6.8 to 7.0	6.8 to 7.0

The District will be able to adjust the pH at the corrosion control facilities to approximately 7.0 units in order to optimize iron and manganese removal. The District will then have to adjust the pH an additional 0.2 units after the primary treatment process to reach the final pH of 7.2 needed for corrosion control within the distribution system.

C. LABORATORY WATER QUALITY DATA

The MassDEP approved laboratory data are shown in Tables 4-4 through 4-9. The laboratory data sheets are included within Appendix C. The laboratory data confirm the iron, manganese, and pH data collected in the field as shown in Tables 4-4 through 4-7. Filtered water iron and manganese levels were below the SMCLs for all sampling tests.

Tables 4-8 and 4-9 show the one time laboratory testing data. All of the data for the raw water and filtered waters are below the Secondary Maximum Contaminant Levels (SMCLs), Maximum Contaminant Levels (MCLs), and/or Office of Research and Standards Goals (ORSGs), except for Fe and Mn in the raw water.

**TABLE 4-4
RAW WATER AND GREENSANDPLUS WATER QUALITY
WELL NO. 20**

Sample ID	Run No.	Run Duration (hours)	Sample Time (hours)	pH	Alkalinity (mg/L as CaCO3)	Total Fe (mg/L)	Dissolved Fe (mg/L)	Total Mn (mg/L)	Dissolved Mn (mg/L)	
Raw Water	Run No. 2G	19.5	19	5.7	8	0.75	0.76	0.06	0.06	
	Run No. 3G	24	23	5.8	10	0.69	0.67	0.06	0.06	
	Run No. 4G	48	23	5.7	8	0.57	0.52	0.052	0.051	
		48	47	5.5	9	0.59	0.6	0.05	0.05	
	Run No. 5G	95	23	5.4	10	0.62	0.57	0.05	0.05	
		95	46	5.3	7	0.54	0.57	0.05	0.05	
		95	71	5.5	7	0.74	0.63	0.06	0.05	
		95	94	5.3	7	0.58	0.64	0.05	0.05	
	GreensandPlus	Run No. 2G	19.5	19	6.6	42	0.1	0.06	<0.01	<0.01
		Run No. 3G	24	23	7.0	41	<0.05	<0.05	<0.01	<0.01
48			23	6.5	43	<0.05	<0.05	<0.01	<0.01	
Run No. 4G		48	47	6.8	48	<0.05	<0.05	<0.01	<0.01	
		95	23	6.4	38	<0.05	<0.05	<0.01	<0.01	
Run No. 5G		95	46	6.4	40	<0.05	<0.05	<0.01	<0.01	
		95	71	6.3	40	<0.05	<0.05	<0.01	<0.01	
		95	94	6.3	39	0.08	<0.05	<0.01	<0.01	

All data from MassDEP Approved Laboratory.

**TABLE 4-5
RAW WATER AND LAYNEOX WATER QUALITY
WELL NO. 20**

Sample ID	Run No.	Run Duration (hours)	Sample Time (hours)	pH	Alkalinity (mg/L as CaCO3)	Total Fe (mg/L)	Dissolved Fe (mg/L)	Total Mn (mg/L)	Dissolved Mn (mg/L)
Raw Water*	Run No. 2L	24	23	5.7	8	0.75	0.76	0.06	0.06
	Run No. 3L	24	22	5.8	10	0.69	0.67	0.06	0.06
	Run No. 4L	46	21	5.7	8	0.57	0.52	0.052	0.051
		46	45	5.5	9	0.59	0.6	0.05	0.05
	Run No. 5L	49	22	5.4	10	0.62	0.57	0.05	0.05
		49	48	5.3	7	0.54	0.57	0.05	0.05
	Run No. 9L*	50	3	6.6	41	0.57	0.12	0.05	0.05
		50	26.5	6.4	40	0.62	0.16	0.05	0.05
		50	49	5.9	38	0.55	0.12	0.05	0.05
	LayneOx	Run No. 2L	24	23	6.2	32	0.05	<0.05	<0.01
Run No. 3L		24	22	6.4	32	<0.05	<0.05	<0.01	<0.01
		46	21	6.4	28	<0.05	<0.05	0.02	<0.01
Run No. 4L		46	45	6.3	27	0.1	<0.05	<0.01	<0.01
		49	22	6.6	39	0.07	<0.05	<0.01	<0.01
Run No. 5L		49	48	6.4	50	0.12	<0.05	<0.01	<0.01
		50	3	6.7	40	<0.05	0.05	<0.01	<0.01
Run No. 9L		50	26.5	6.4	40	0.11	<0.05	0.01	<0.01
		50	49	6.4	38	0.29	0.54	0.02	<0.01

All data from MassDEP Approved Laboratory.

*Note that the raw water for Run No. 9L was taken at the Corrosion Control Facility and had been chemically adjusted with KOH. Raw water for the other runs was sampled at the well pumping station before any chemical addition.

**TABLE 4-6
RAW WATER AND GREENSANDPLUS WATER QUALITY
WELL NO. 8**

Sample ID	Run No.	Run Duration (hours)	Sample Time (hours)	pH	Alkalinity (mg/L as CaCO3)	Total Fe (mg/L)	Dissolved Fe (mg/L)	Total Mn (mg/L)	Dissolved Mn (mg/L)	
Raw Water	Run No. 6G	24	24	5	3	0.26	0.2	0.15	0.15	
	Run No. 7G	24	23	5.1	<2	0.28	0.23	0.15	0.15	
	Run No. 8G	116	20	20	4.9	4	0.19	0.28	0.14	0.14
		116	44	44	5	<2	0.25	0.24	0.14	0.14
		116	74	74	5.2	3	0.33	0.21	0.15	0.14
		116	98	98	5.1	7	0.23	0.21	0.14	0.14
	116	115	115	5.1	3	0.25	0.17	0.13	0.13	
GreensandPlus	Run No. 6G	24	24	6.8	34	<0.05	<0.05	<0.01	<0.01	
	Run No. 7G	24	23	6.4	30	<0.05	<0.05	<0.01	<0.01	
	Run No. 8G	116	20	20	6.4	31	<0.05	<0.05	<0.01	<0.01
		116	44	44	6.5	31	<0.05	<0.05	<0.01	<0.01
		116	74	74	6.8	30	0.11	<0.05	0.01	<0.01
		116	98	98	6.6	30	<0.05	<0.05	<0.01	<0.01
	116	115	115	6.6	29	<0.05	<0.05	<0.01	<0.01	

All data from MassDEP Approved Laboratory.

**TABLE 4-7
RAW WATER AND LAYNEOX WATER QUALITY
WELL NO. 8**

Sample ID	Run No.	Run Duration (hours)	Sample Time (hours)	pH	Alkalinity (mg/L as CaCO3)	Total Fe (mg/L)	Dissolved Fe (mg/L)	Total Mn (mg/L)	Dissolved Mn (mg/L)
Raw Water	Run No. 6L	23	23	5	3	0.26	0.2	0.15	0.15
	Run No. 7L	24	23	5.1	<2	0.28	0.23	0.15	0.15
	Run No. 8L	48.5	19	4.9	4	0.19	0.28	0.14	0.14
		48.5	44	5	<2	0.25	0.24	0.14	0.14
LayneOx	Run No. 6L	23	23	6.7	25	<0.05	<0.05	<0.01	<0.01
	Run No. 7L	24	23	6.5	36	0.09	<0.05	<0.01	<0.01
	Run No. 8L	48.5	19	6.3	32	0.08	<0.05	<0.01	<0.01
		48.5	44	6.2	31	<0.05	<0.05	<0.01	<0.01

All data from MassDEP Approved Laboratory.

TABLE 4-8
WATER QUALITY
APRIL 13, 2007: RUN NO. 4G AND RUN NO. 4L
WELL NO. 20

Parameter	Raw Water	Greensand Effluent	LayneOx Effluent	SMCL	MCL	ORSG
Total Fe (mg/L)	0.57	<0.05	<0.05	0.3	--	--
Total Mn (mg/L)	0.052	<0.01	0.02	0.05	--	--
pH (pH units)	5.7	6.5	6.4	6.5-8.5	--	--
Alkalinity (mg/L as CaCO ₃)	8	43	28	--	--	--
Total Hardness (mg/L)	21	20	21	--	--	--
True Color (CU)	<5	<5	<5	15	--	--
Apparent Color (CU)	<5	<5	<5	15	--	--
Fluoride (mg/L)	0.05	0.04	0.04	2	4	--
Nitrate as N (mg/L)	0.12	0.12	0.12	--	10	--
Sulfate (mg/L)	14	14	14	250	--	--
Turbidity (NTU) - See Note 1	0.6	0.4	0.3	--	TT	--
Total CO ₂ (mg/L)	47	70	63	--	--	--
Total Cyanide (mg/L)	<0.01	<0.01	<0.01	--	0.2	--
Antimony (mg/L)	<0.003	<0.003	<0.003	--	0.006	--
Arsenic (mg/L)	<0.005	<0.005	<0.005	--	0.01	--
Barium (mg/L)	<0.2	<0.2	<0.2	--	2	--
Beryllium (mg/L)	<0.002	<0.002	<0.002	--	0.004	--
Cadmium (mg/L)	<0.0025	<0.0025	<0.0025	--	0.005	--
Calcium (mg/L)	4.0	3.9	4.0	--	--	--
Chromium (mg/L)	<0.01	<0.01	<0.01	--	0.1	--
Magnesium (mg/L)	2.6	2.6	2.7	--	--	--
Mercury (mg/L)	<0.0002	<0.0002	<0.0002	--	--	--
Nickel (mg/L)	<0.04	<0.04	<0.04	--	--	0.1
Potassium (mg/L)	1	28	17	--	--	--
Selenium (mg/L)	<0.005	<0.005	<0.005	--	0.05	--
Sodium (mg/L)	12	13	14	--	--	20
Thallium (mg/L)	<0.001	<0.001	<0.001	--	0.002	--
Total Coliforms (col/100 ml)	Absent	Absent	Absent	--	--	--
VOCs	BDL	BDL	BDL	--	Vary	

BDL = Below Detection Limit

TT = Treatment Technique

Note 1: Turbidity is a measure of the clarity of water and is commonly expressed in nephelometric turbidity units (NTU). Suspended solids and colloidal matter contribute to turbidity. Turbidity may be composed of organic and/or inorganic constituents. Organic particulates may contain high concentrations of bacteria, viruses, and protozoa. Turbid conditions may increase the possibility for waterborne disease and are regulated on surface waters or groundwater sources under the influence of surface waters. In general the turbidity in the source water must not exceed 5.0 NTU. If it does, the source requires filtration to achieve filtered water turbidity of 0.3 NTU in 95% of the samples taken.

**TABLE 4-9
WATER QUALITY
APRIL 19, 2007: RUN NO. 8G AND RUN NO. 8L
WELL NO. 8**

Parameter	Raw Water	Greensand Effluent	LayneOx Effluent	SMCL	MCL	ORSG
Total Fe (mg/L)	0.19	<0.05	0.08	0.3	--	--
Total Mn (mg/L)	0.14	<0.01	<0.01	0.05	--	--
pH (pH units)	4.9	6.4	6.3	6.8-	--	--
Alkalinity (mg/L as CaCO3)	4	31	32		--	--
Total Hardness (mg/L)	8.6	8.8	8.3	--		--
True Color (CU)	<5	<5	<5	15	--	--
Apparent Color (CU)	<5	<5	<5	15	--	--
Fluoride (mg/L)	<0.04	--	<0.04	2	4	--
Nitrate as N (mg/L)	0.06	0.05	0.08	--	10	--
Sulfate (mg/L)	6.1	6.2	6.1	250	--	--
Turbidity (NTU) - See Note 1	0.4	0.3	0.4	--	TT	--
Total CO2 (mg/L)	45	44	110	--		--
Total Cyanide (mg/L)	<0.01	<0.01	<0.01	--	0.2	--
Antimony (mg/L)	<0.003	<0.003	<0.003	--	0.006	--
Arsenic (mg/L)	<0.005	<0.005	<0.005	--	0.01	--
Barium (mg/L)	<0.2	<0.2	<0.2	--	2	--
Beryllium (mg/L)	<0.002	<0.002	<0.002	--	0.004	--
Cadmium (mg/L)	<0.0025	<0.0025	<0.0025	--	0.005	--
Calcium (mg/L)	1.0	1.0	1.0	--		--
Chromium (mg/L)	<0.01	<0.01	<0.01	--	0.1	--
Magnesium (mg/L)	1.5	1.5	1.4	--		--
Mercury (mg/L)	<0.0002	<0.0002	<0.0002	--		--
Nickel (mg/L)	<0.04	<0.04	<0.04	--		0.1
Potassium (mg/L)	<1	23	23	--		--
Selenium (mg/L)	<0.005	<0.005	<0.005	--	0.05	--
Sodium (mg/L)	8	9	9	--		20
Thallium (mg/L)	<0.001	<0.001	<0.001	--	0.002	--
Total Coliforms (col/100 ml)	Absent	Absent	Absent	--		--
VOCs				--		Vary

BDL = Below Detection Limit

TT = Treatment Technique

Note 1: Turbidity is a measure of the clarity of water and is commonly expressed in nephelometric turbidity units (NTU). Suspended solids and colloidal matter contribute to turbidity. Turbidity may be composed of organic and/or inorganic constituents. Organic particulates may contain high concentrations of bacteria, viruses, and protozoa. Turbid conditions may increase the possibility for waterborne disease and are regulated on surface waters or groundwater sources under the influence of surface waters. In general the turbidity in the source water must not exceed 5.0 NTU. If it does, the source requires filtration to achieve filtered water turbidity of 0.3 NTU in 95% of the samples taken.

D. BACKWASH CHARACTERISTICS

All water treatment processes generate some amount of process waste. For the processes examined in this pilot study, the waste is a water stream with elevated concentrations of particulates and trace compounds. Composite samples of the backwash were taken from both systems to determine the waste characteristics for full-scale. Figure 4-24 shows a picture of a sample of the backwash waste. Unlike the transmission main flush water, the backwash waste more readily settled out. It was observed that the backwash waste for the GreensandPlus system settled out more quickly than that for the LayneOx system.

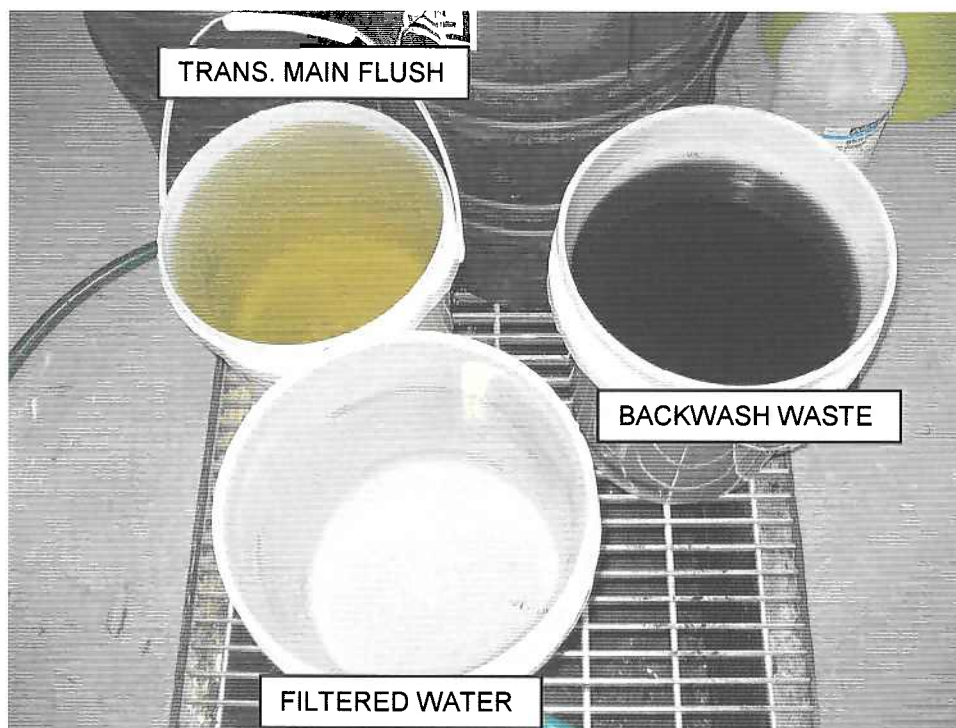

**FIGURE 4-24
BACKWASH WASTE**

Backwash waste samples were taken as composite samples as follows. During the backwash cycle, 0.5 gallons of backwash waste was taken from the discharge hose using a graduated bucket every 60 seconds for 5 minutes of the backwash (2.5 gallons total). The water was then stirred to resuspend any settled particulates and water was drawn from the middle of the bucket for the samples sent to the laboratory for analysis. The GreensandPlus filter backwash characteristics are shown in Table 4-10 and the LayneOx filter backwash characteristics are shown in Table 4-11.

**TABLE 4-10
GREENSANDPLUS SYSTEM
BACKWASH WASTE DATA**

	Well No. 20	Well No. 8
Parameter	Run No. 4G	Run No. 8G
Total Iron (mg/L)	100	100
Total Manganese (mg/L)	6.7	20
Settleable Solids (mL/L)	45	300
Total Suspended Solids (mg/L)	270	800

**TABLE 4-11
LAYNEOX SYSTEM
BACKWASH WASTE DATA**

	Well No. 20	Well No. 8
Parameter	Run No. 4L	Run No. 8L
Total Iron (mg/L)	130	88
Total Manganese (mg/L)	6.9	26
Settleable Solids (mL/L)	180	150
Total Suspended Solids (mg/L)	350	550

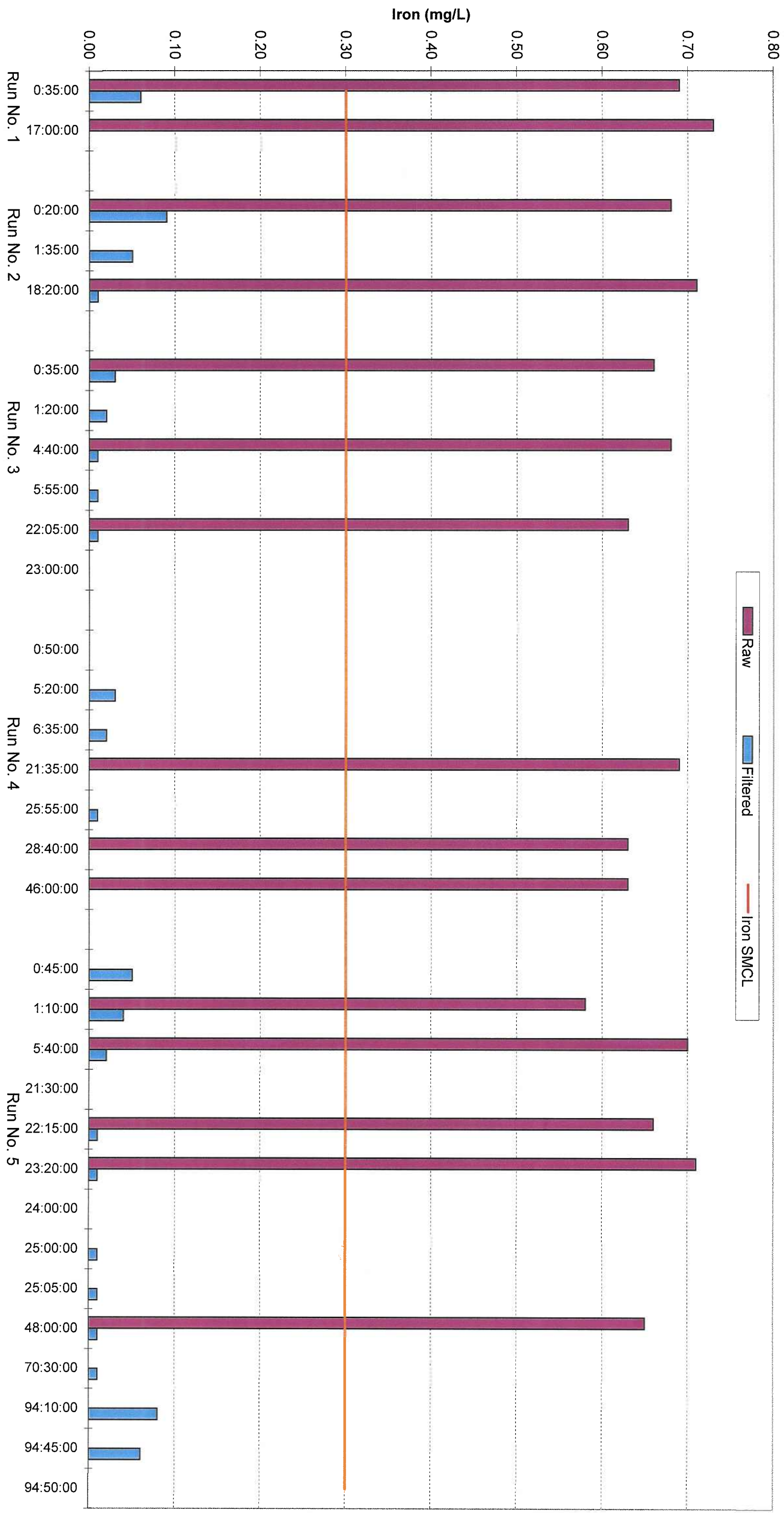

FIGURE 4-1
Dennis Water District
Well No. 20 GreensandPlus Pilot
Field Data - Iron

FIGURE 4-2
Dennis Water District
Well No. 20 LayneOx Pilot
Field Data - Iron

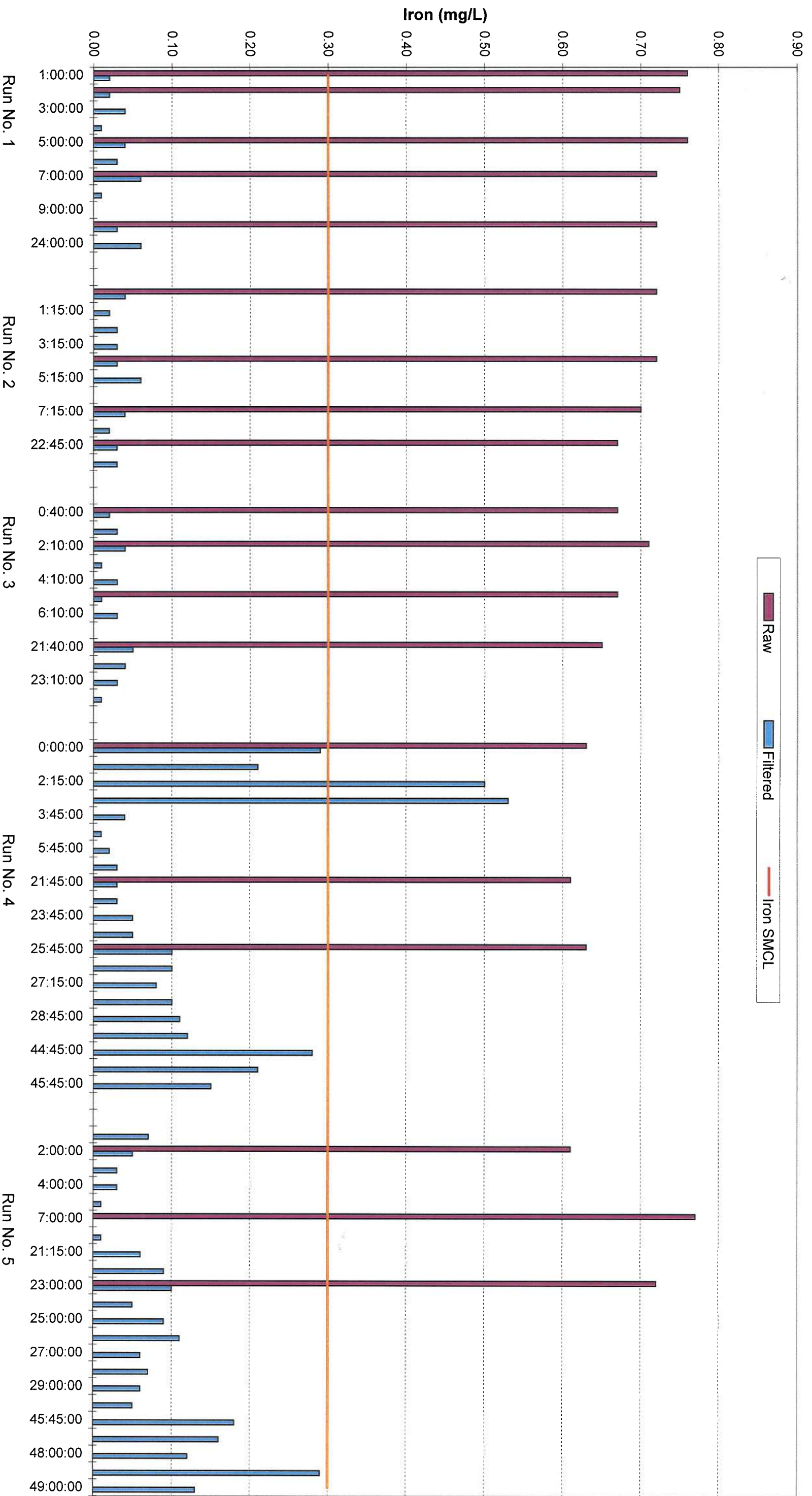

FIGURE 4-3
Dennis Water District
Well No. 8 Greensand Plus Pilot
Field Data - Iron

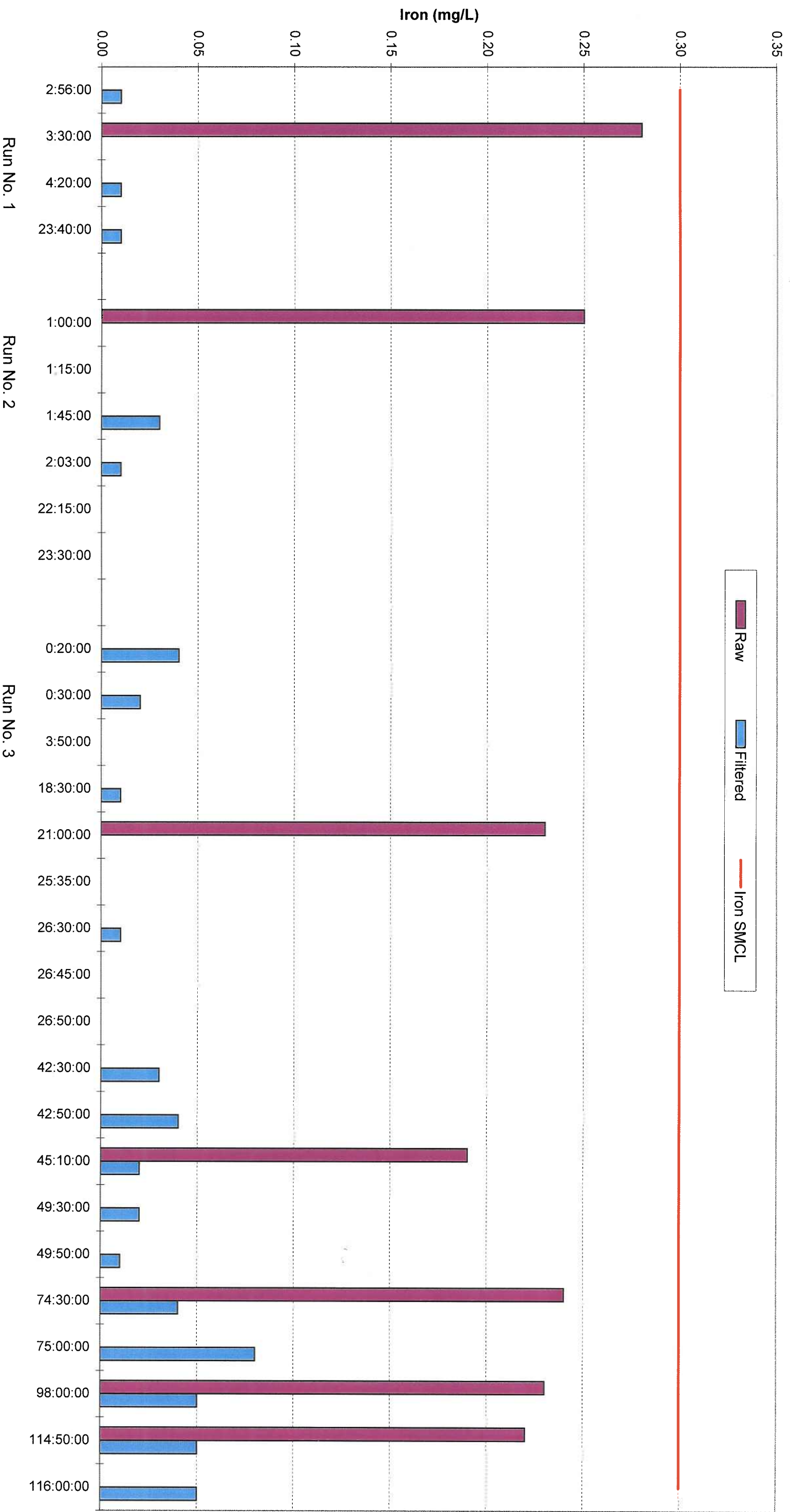

FIGURE 4-4
Dennis Water District
Well No. 8 LayneOX Pilot
Field Data - Iron

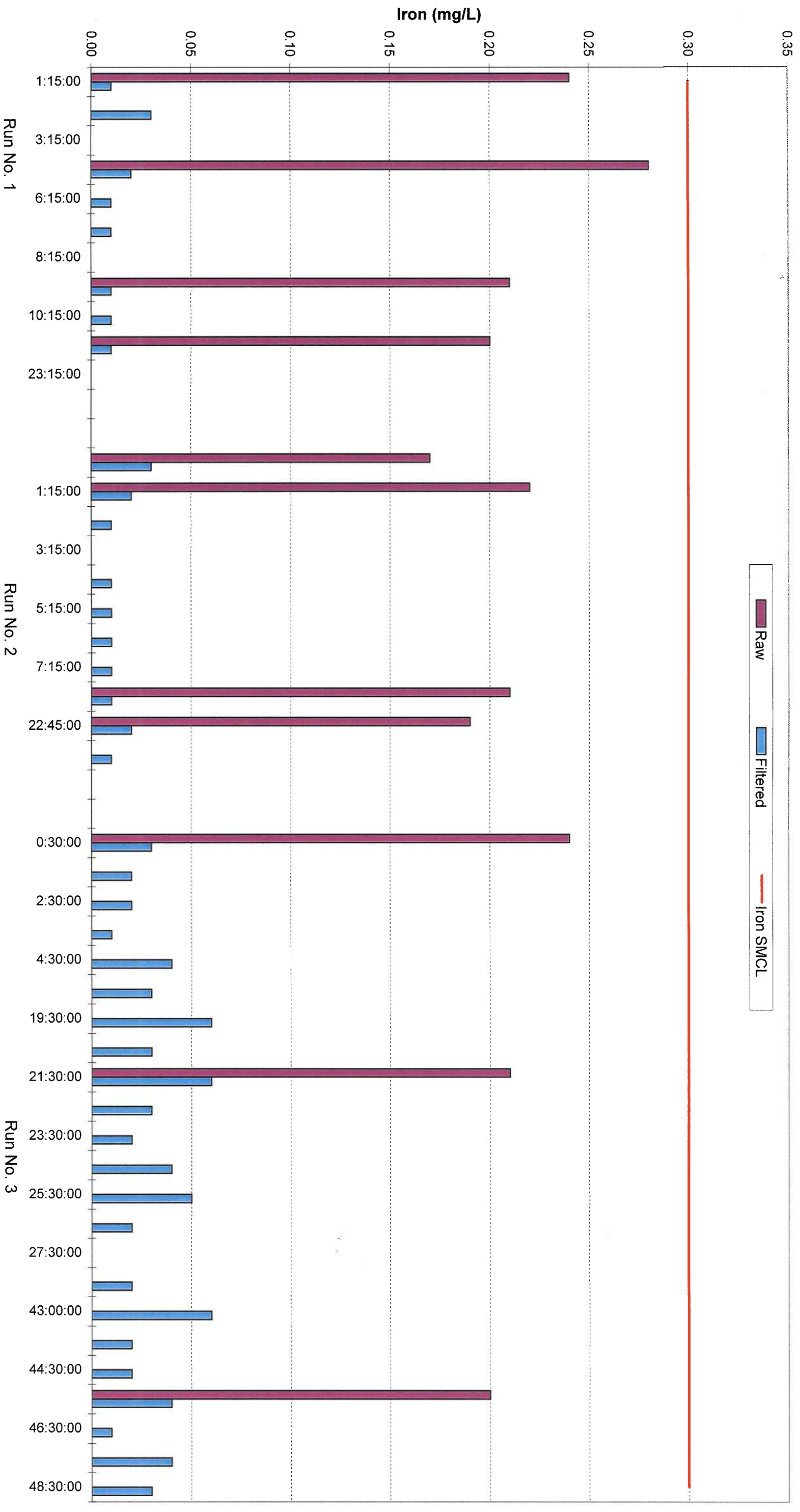

FIGURE 4-5
Dennis Water District
Well No. 20 GreensandPlus Pilot
Field Data - Manganese

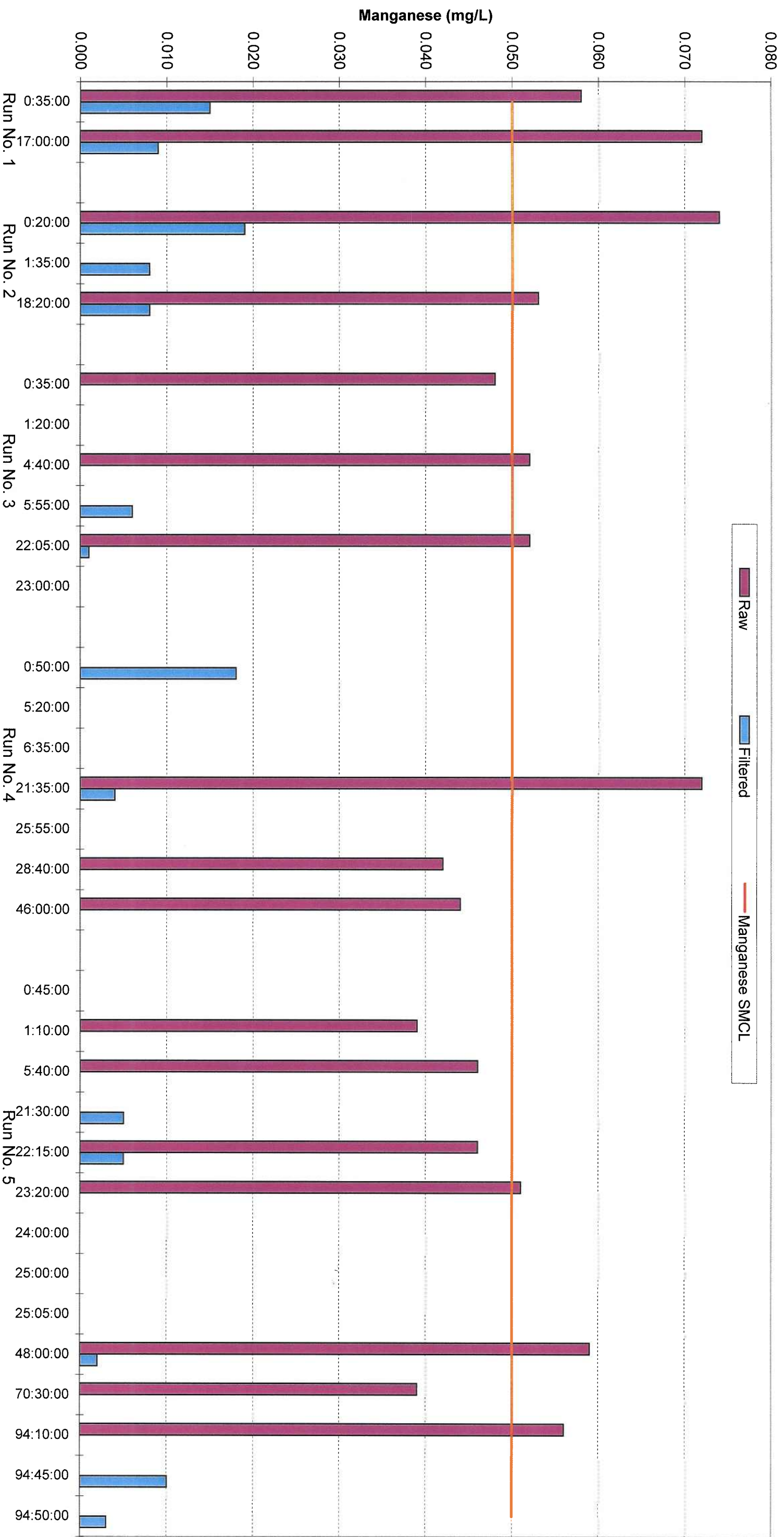

FIGURE 4-6
Dennis Water District
Well No. 20 LayneOx Pilot
Field Data - Manganese

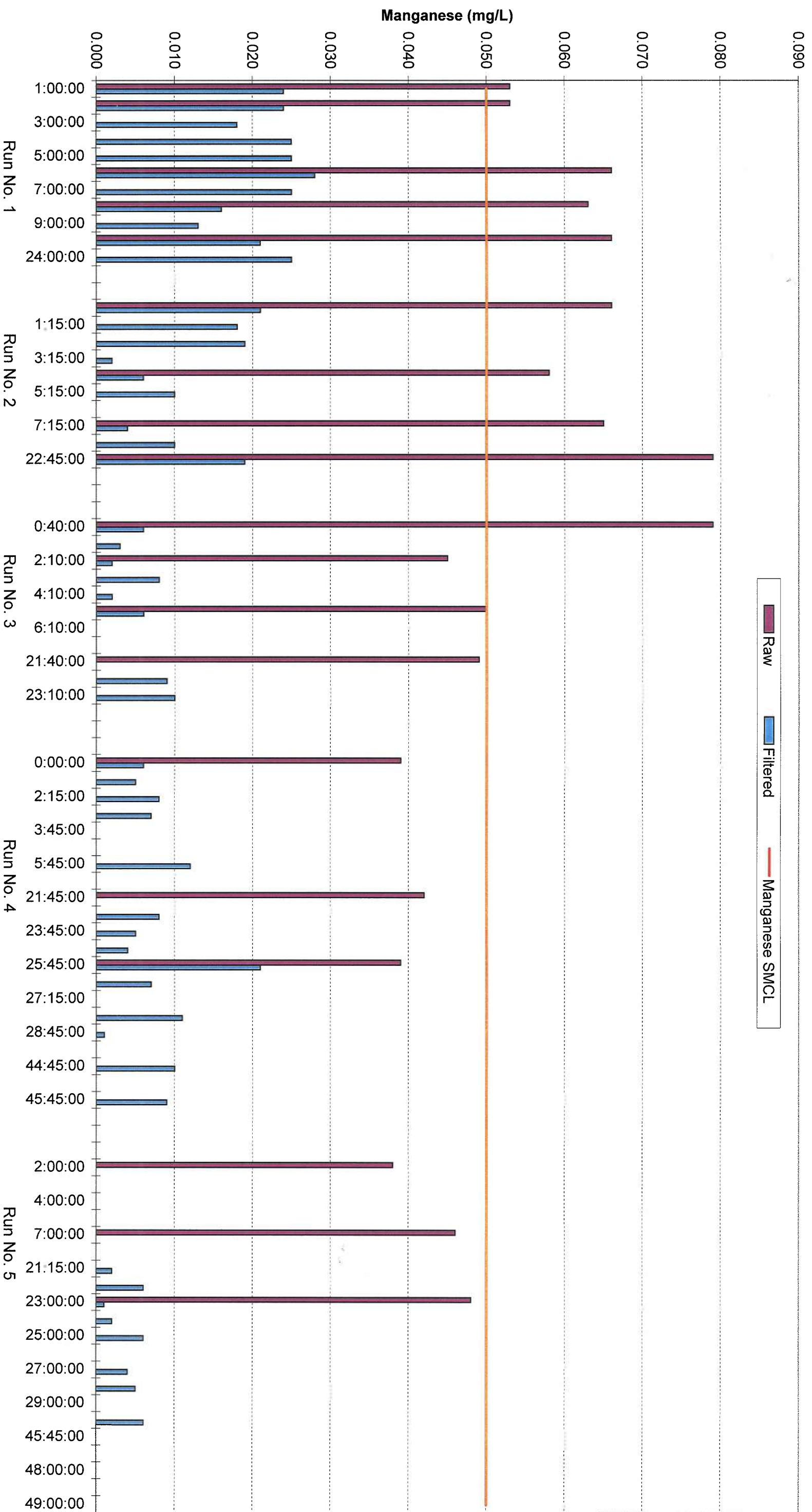
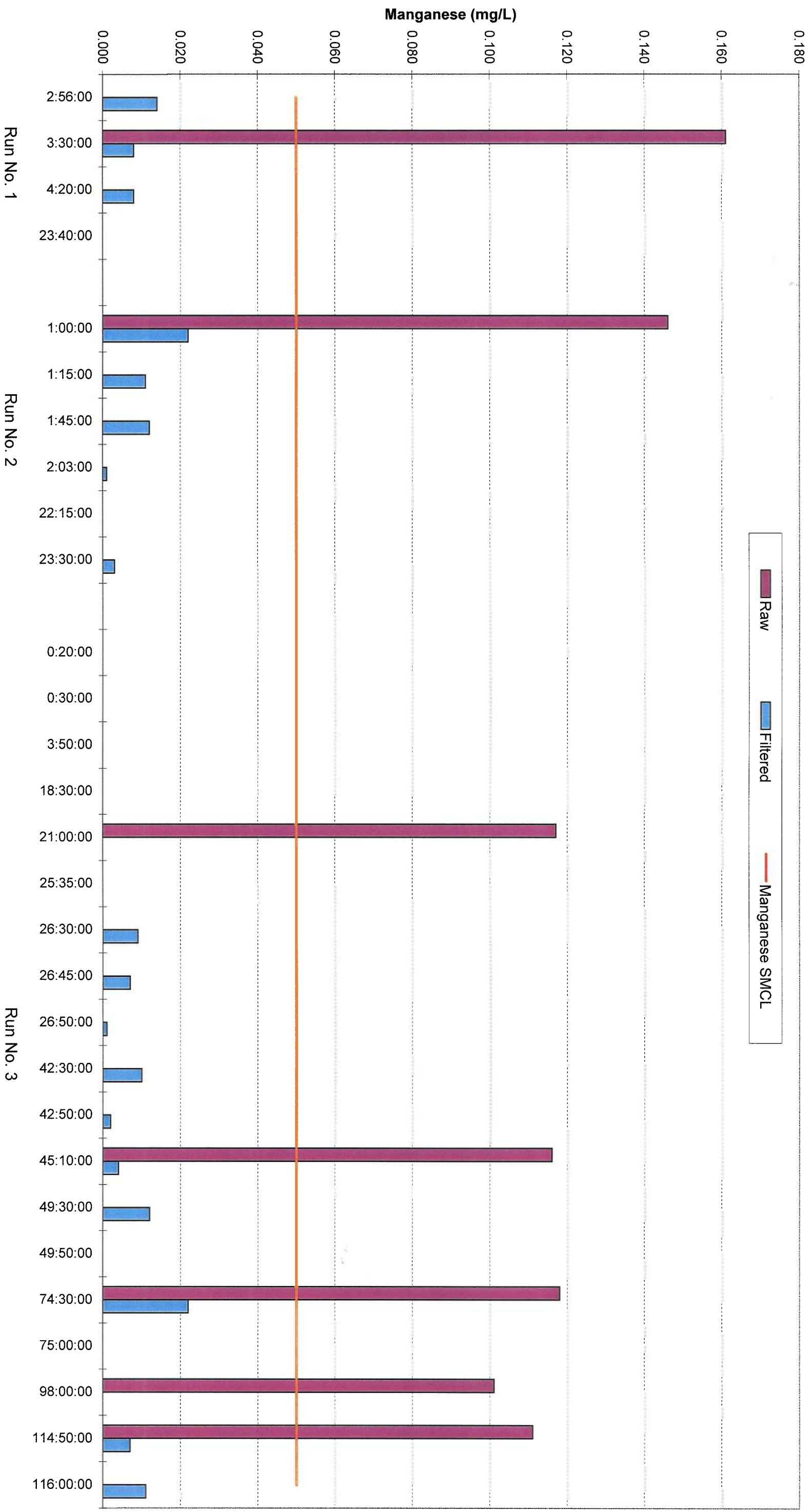

FIGURE 4-7
Dennis Water District
Well No. 20 Greensand Plus Pilot
Field Data - Manganese



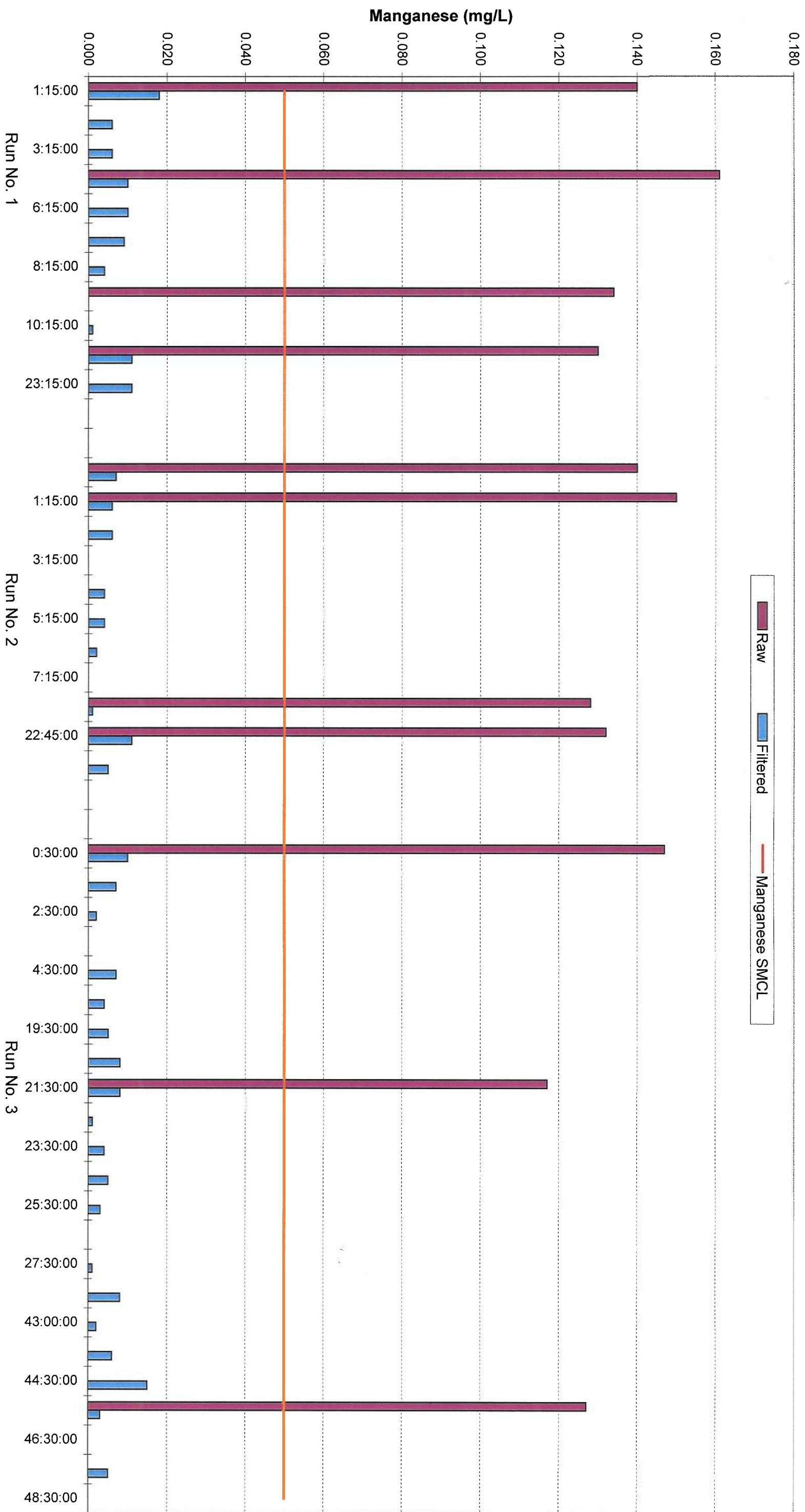

FIGURE 4-8
 Dennis Water District
 Well No. 8 LayneOx Pilot
 Field Data - Manganese

FIGURE 4-9
Dennis Water District
Well No. 20 LayneOx Pilot - 8x20 Mesh Media
Field Data - Iron

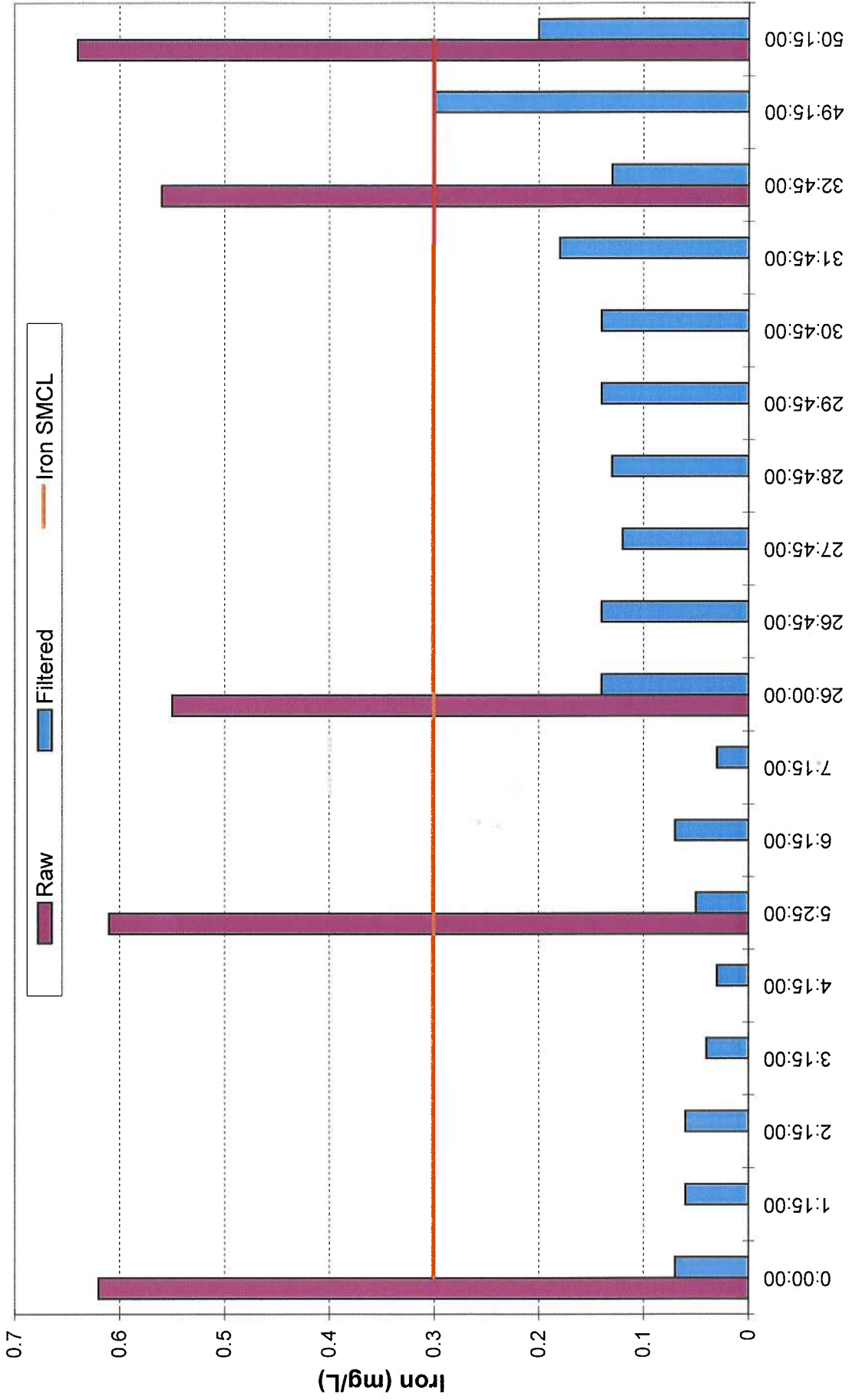

FIGURE 4-10
Dennis Water District
Well No. 20 LayneOx Pilot - 8x20 Mesh Media
Field Data - Manganese

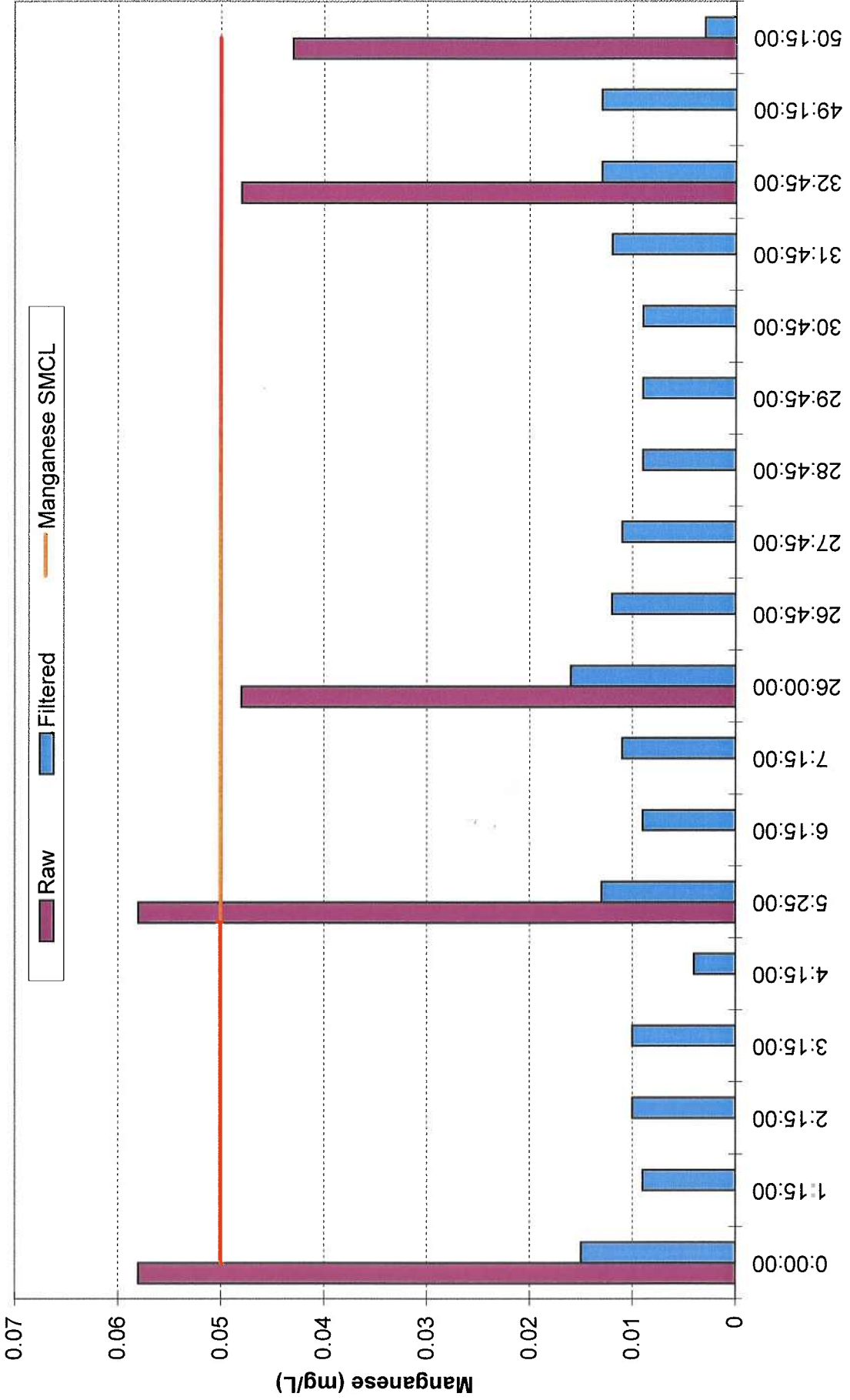

FIGURE 4-11
Dennis Water District
Well No. 20 GreensandPlus Pilot
Filtered Water pH and Iron

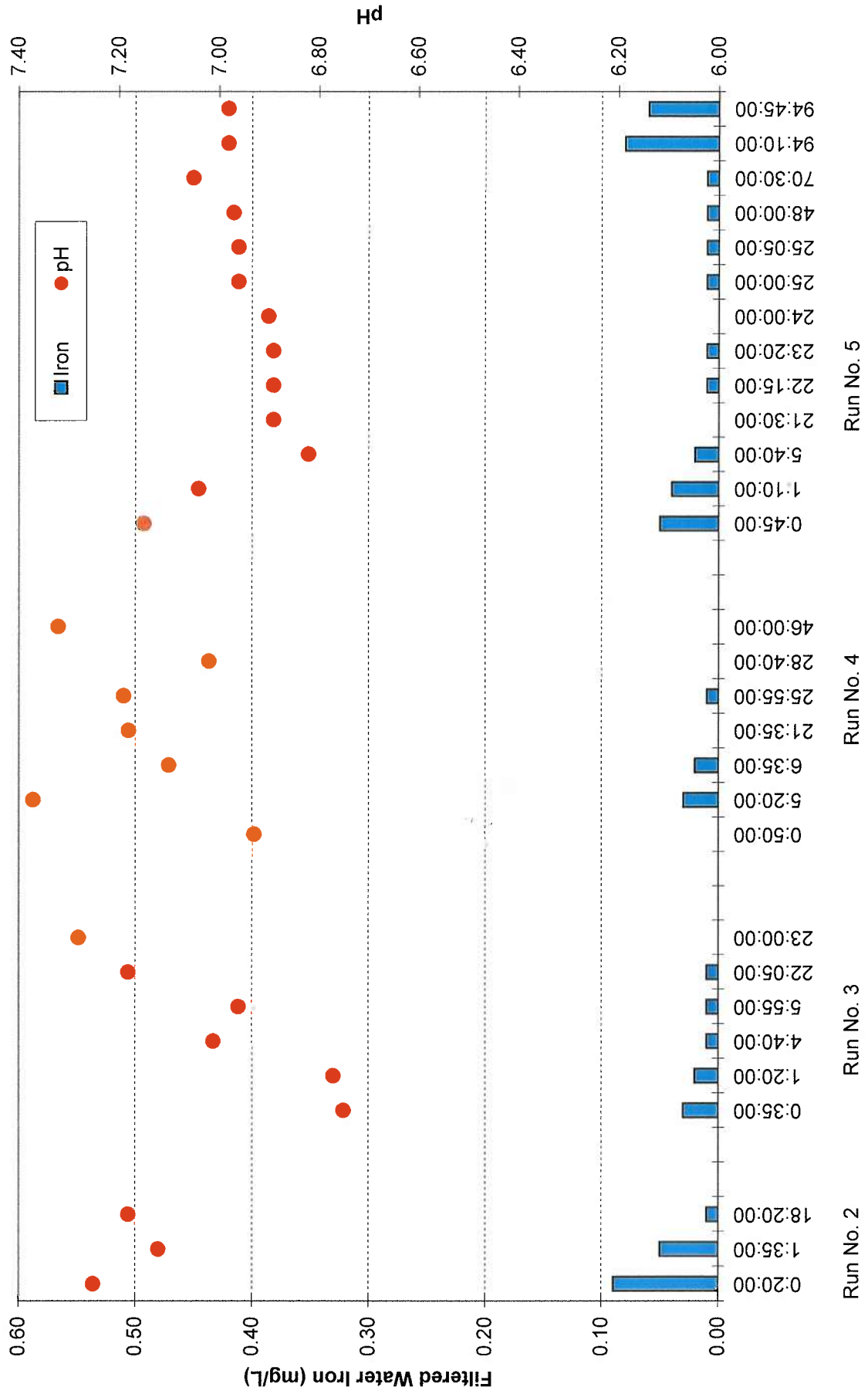

FIGURE 4-12
Dennis Water District
Well No. 20 LayneOx Pilot
Filtered Water pH and Iron

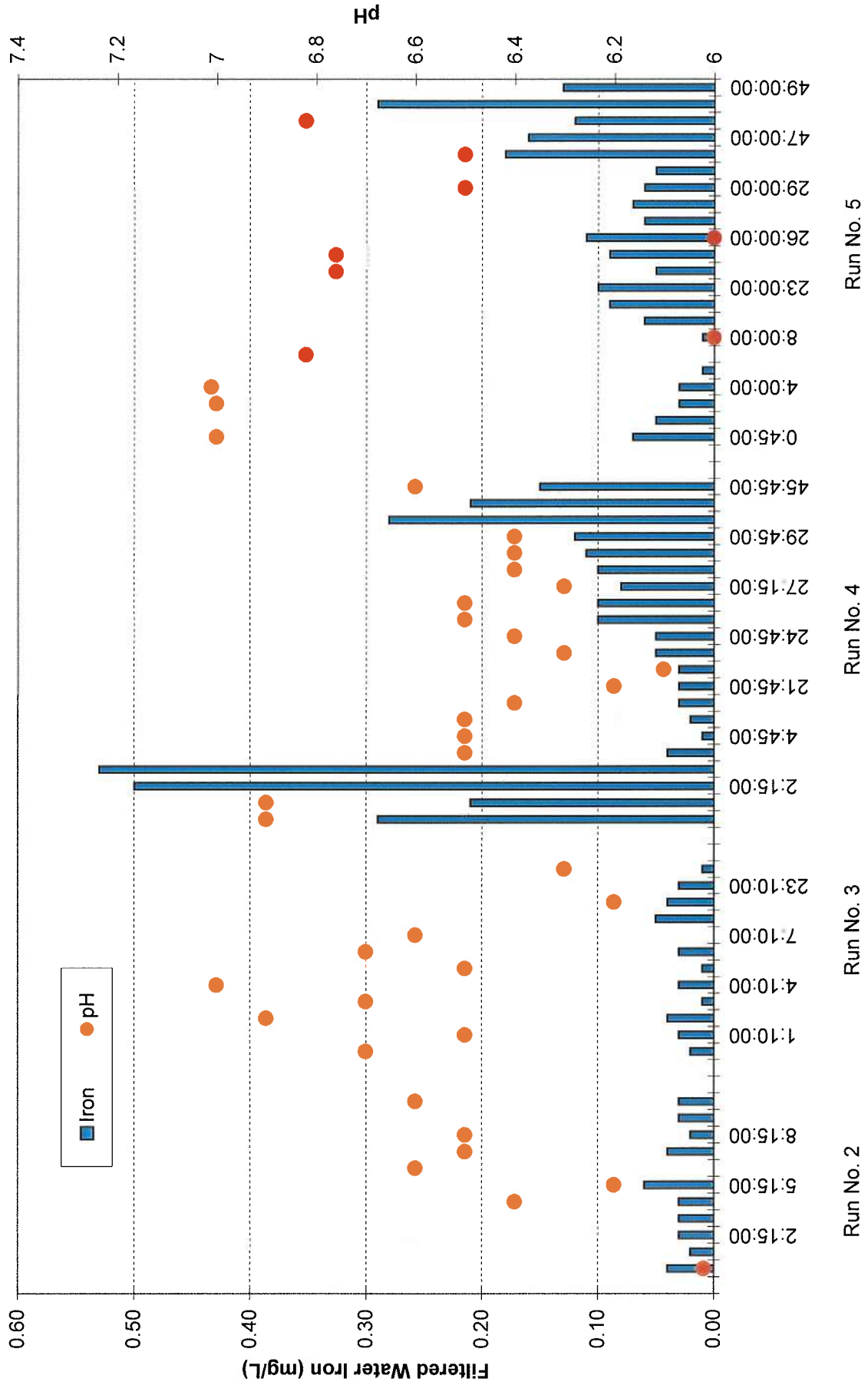

FIGURE 4-13
Dennis Water District
Well No. 8 GreensandPlus Pilot
Filtered Water pH and Iron

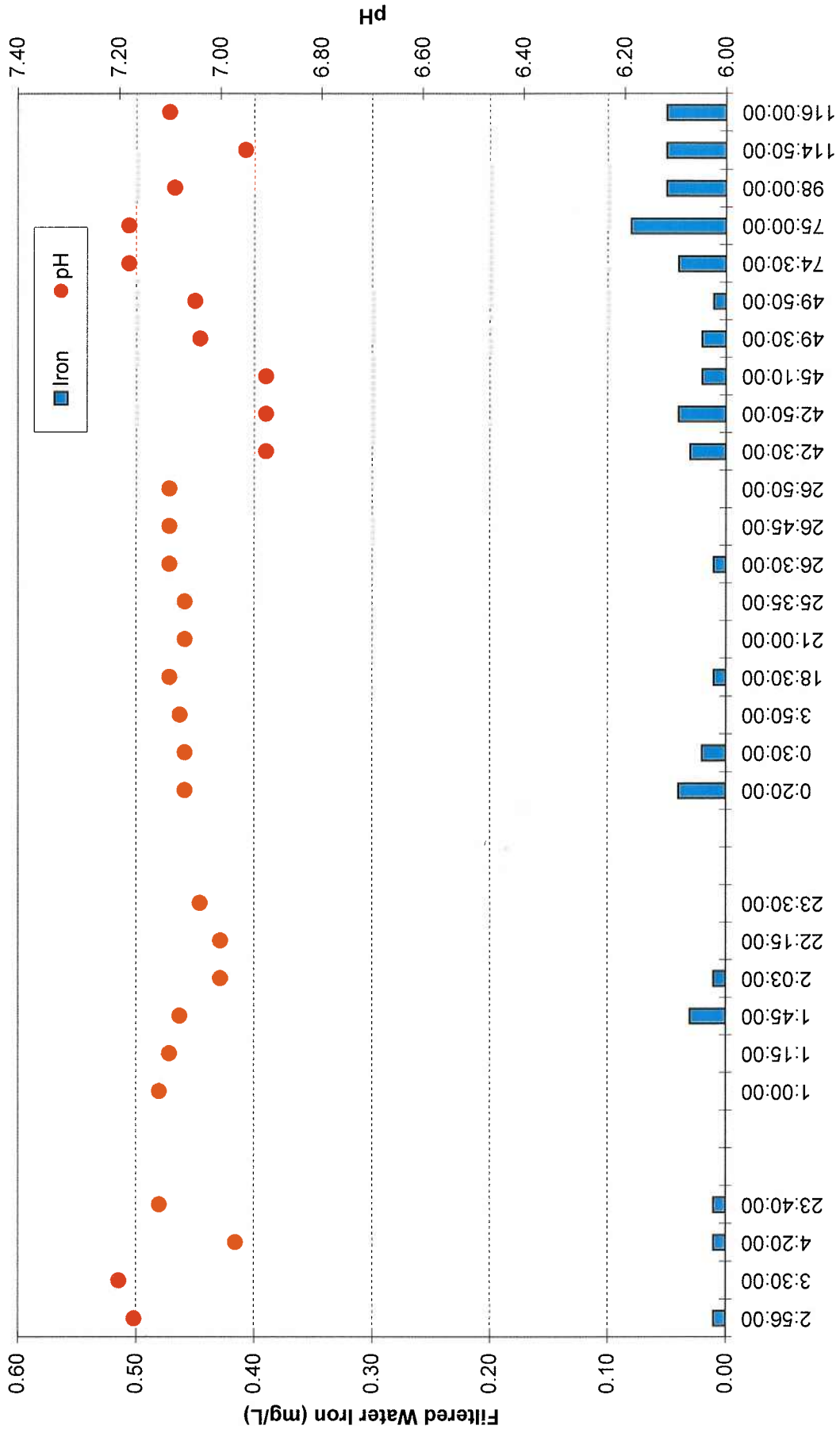

FIGURE 4-14
Dennis Water District
Well No. 8 LayneOx Pilot
Filtered Water pH and Iron

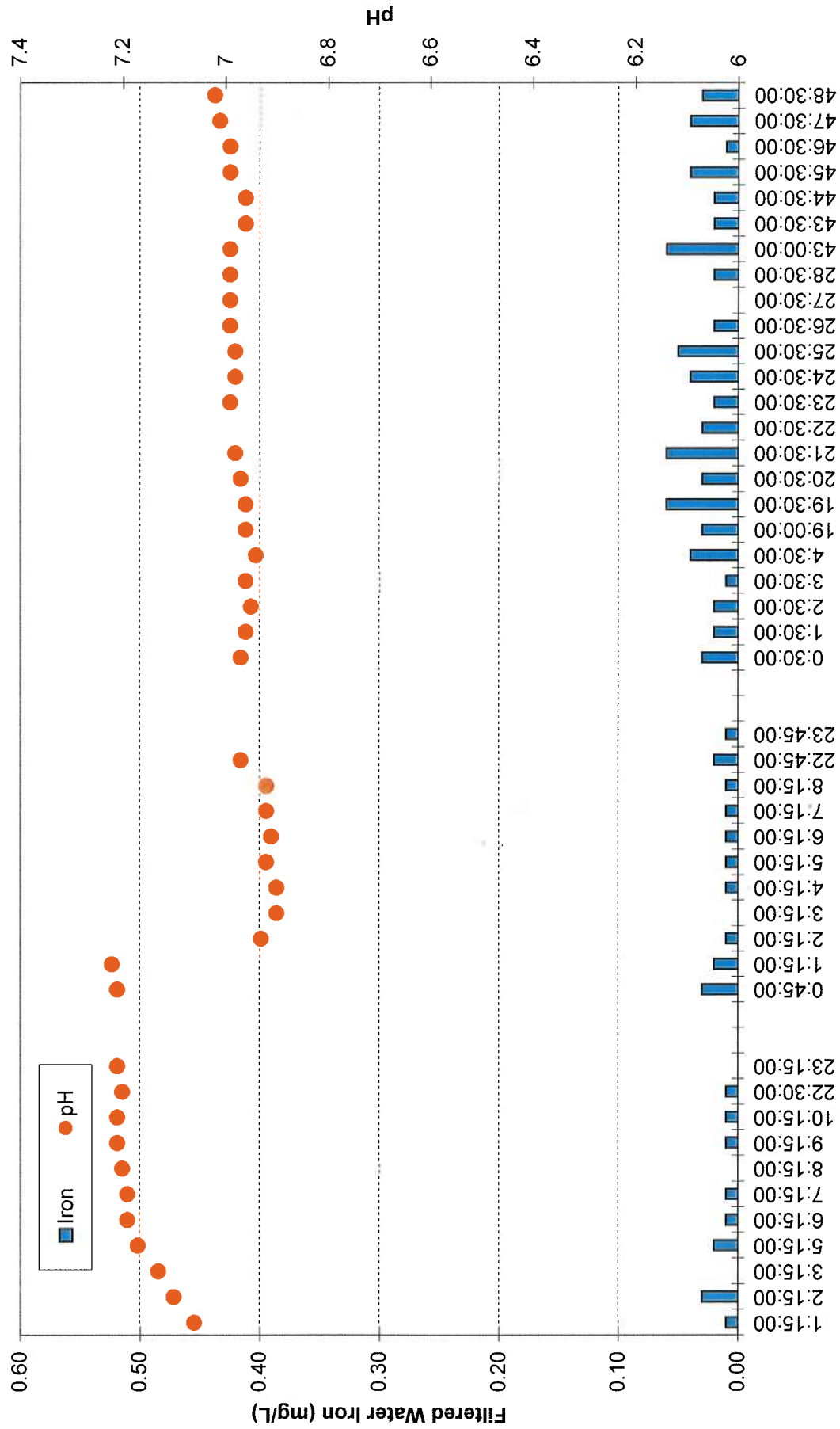

FIGURE 4-15
Dennis Water District
Well No. 20 GreensandPlus Pilot
Filtered Water pH and Manganese

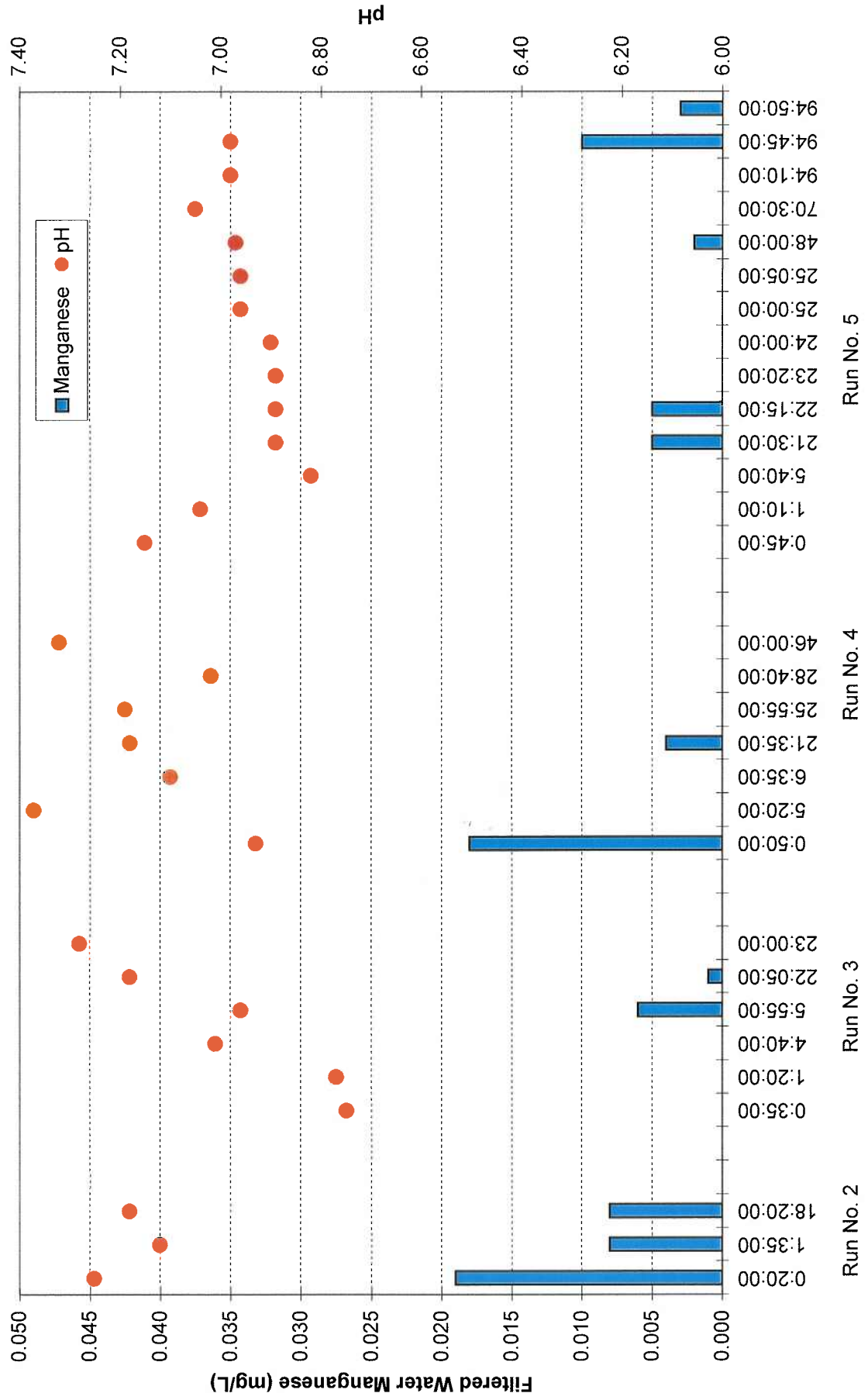

FIGURE 4-16
Dennis Water District
Well No. 20 LayneOx Pilot
Filtered Water pH and Manganese

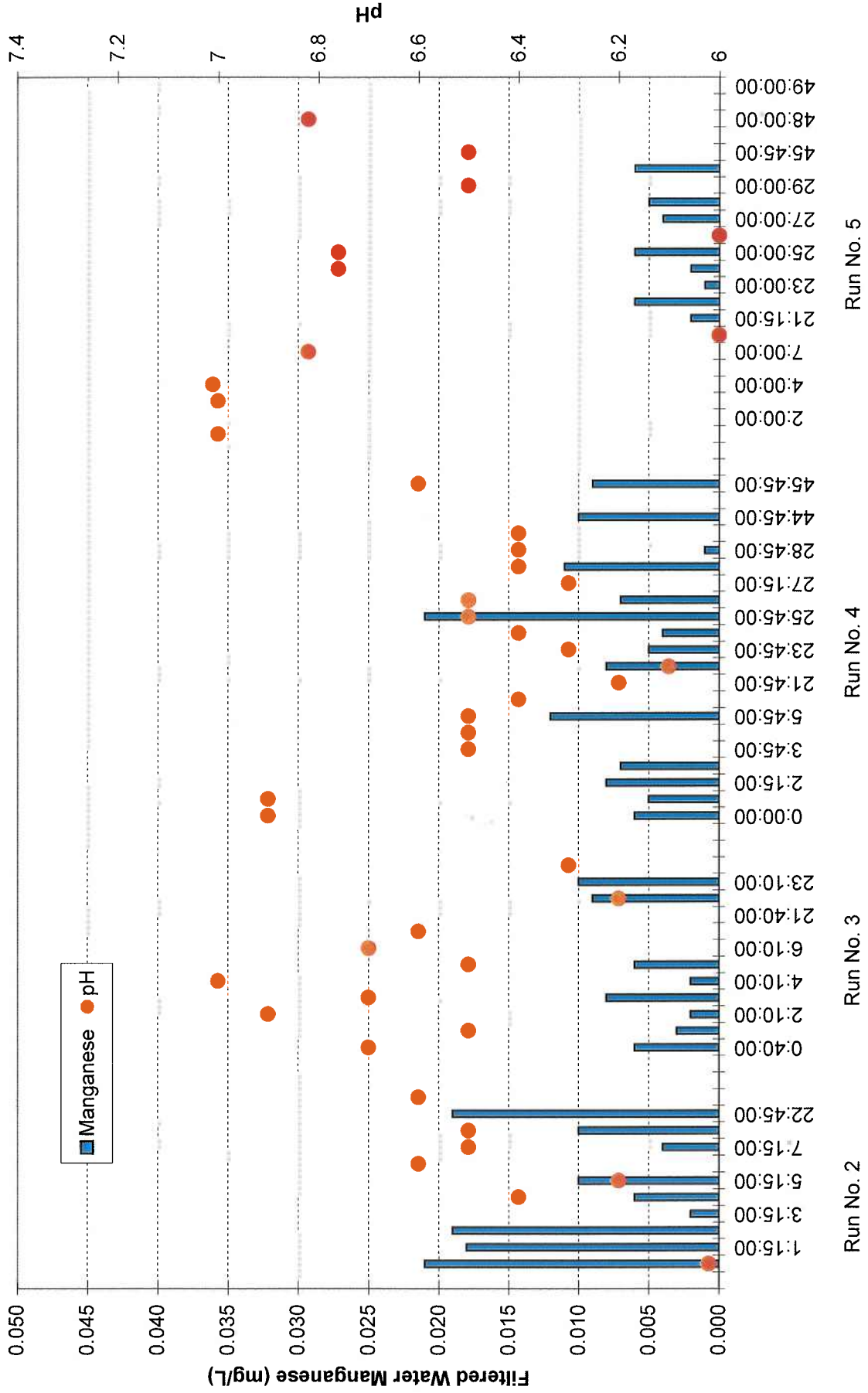

FIGURE 4-17
Dennis Water District
Well No. 8 GreensandPlus Pilot
Filtered Water pH and Manganese

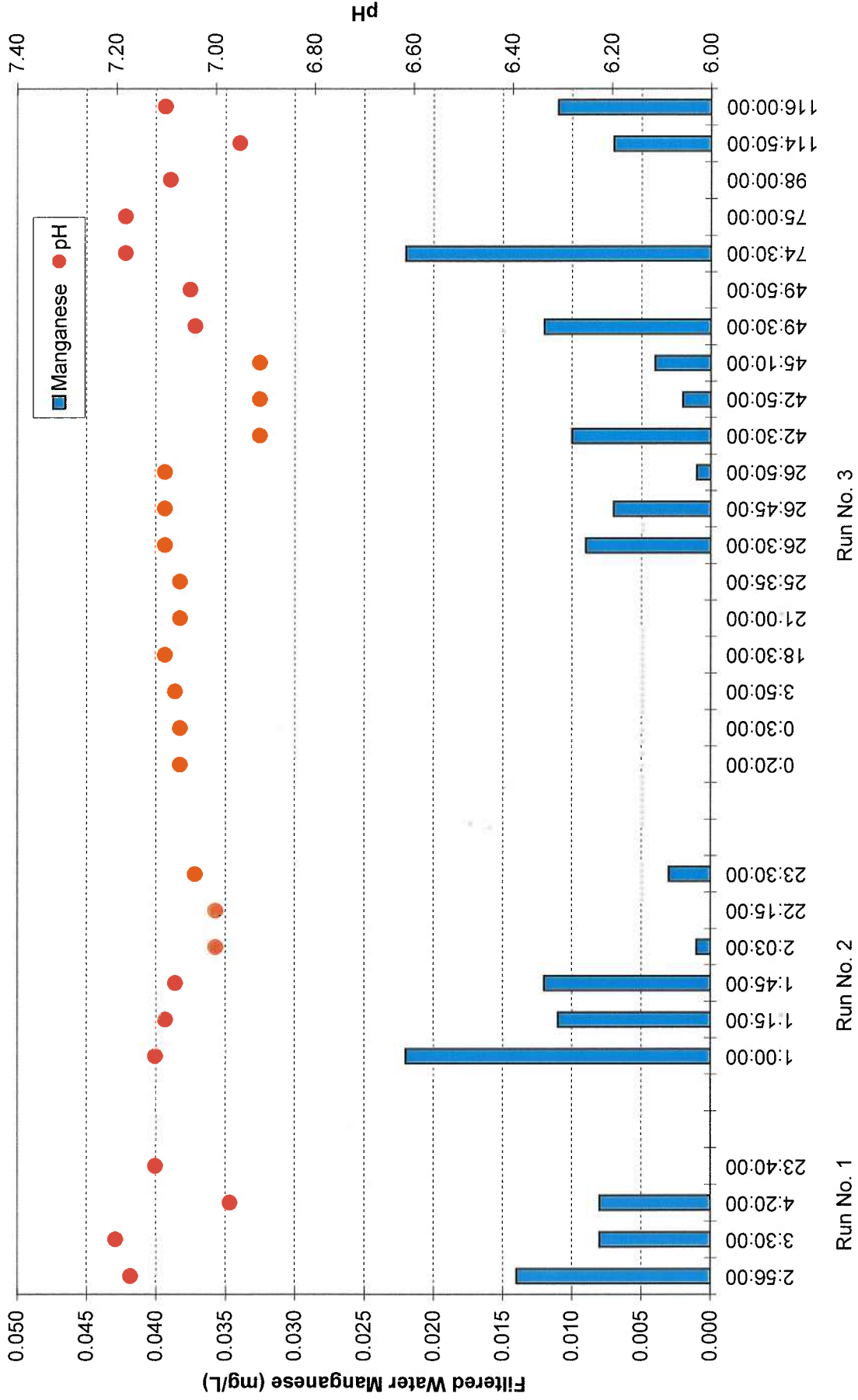

FIGURE 4-18
Dennis Water District
Well No. 8 LayneOx Pilot
Filtered Water pH and Manganese

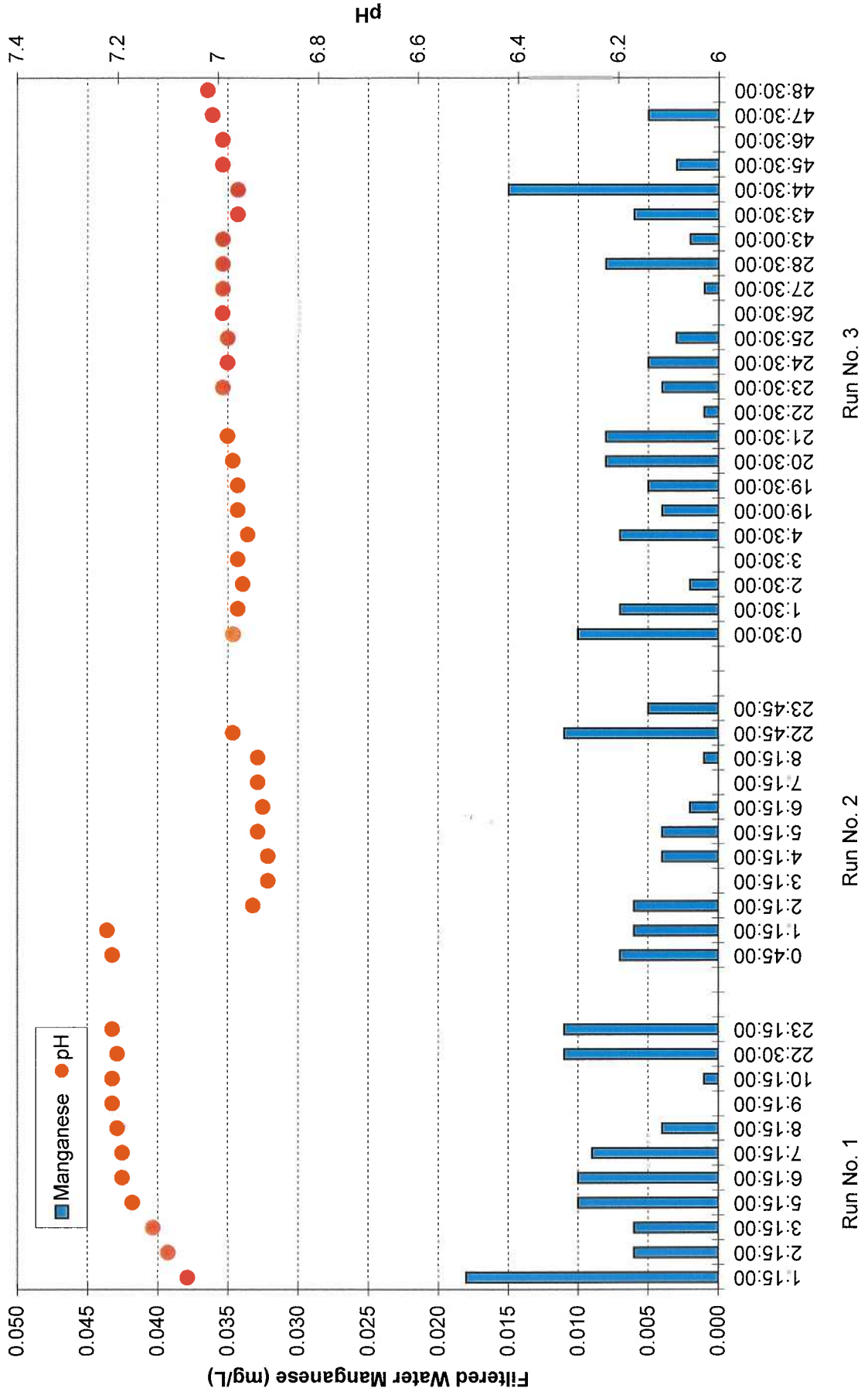

FIGURE 4-19
Dennis Water District
Well No. 20 GreensandPlus Pilot
Differential Pressure

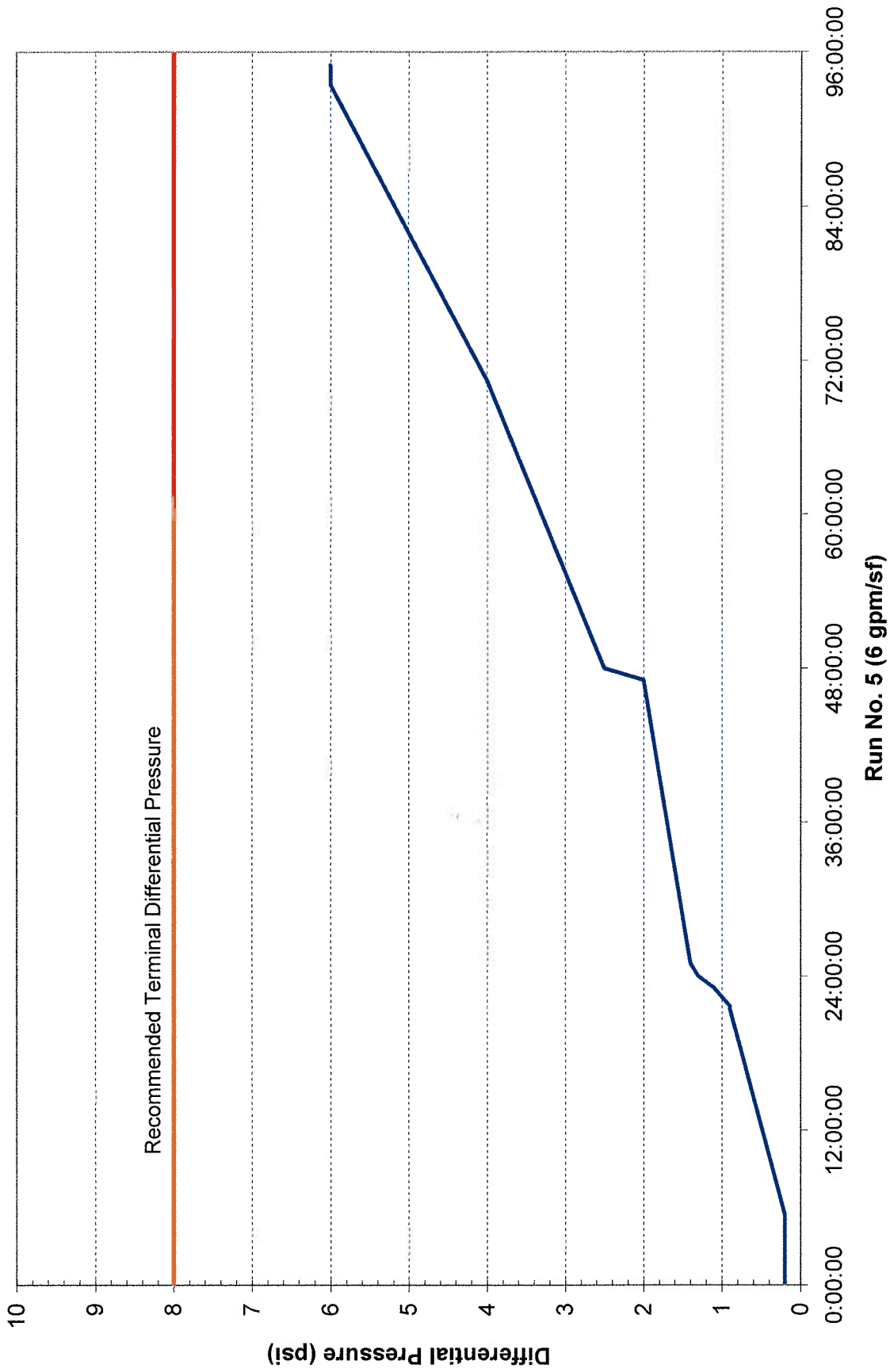
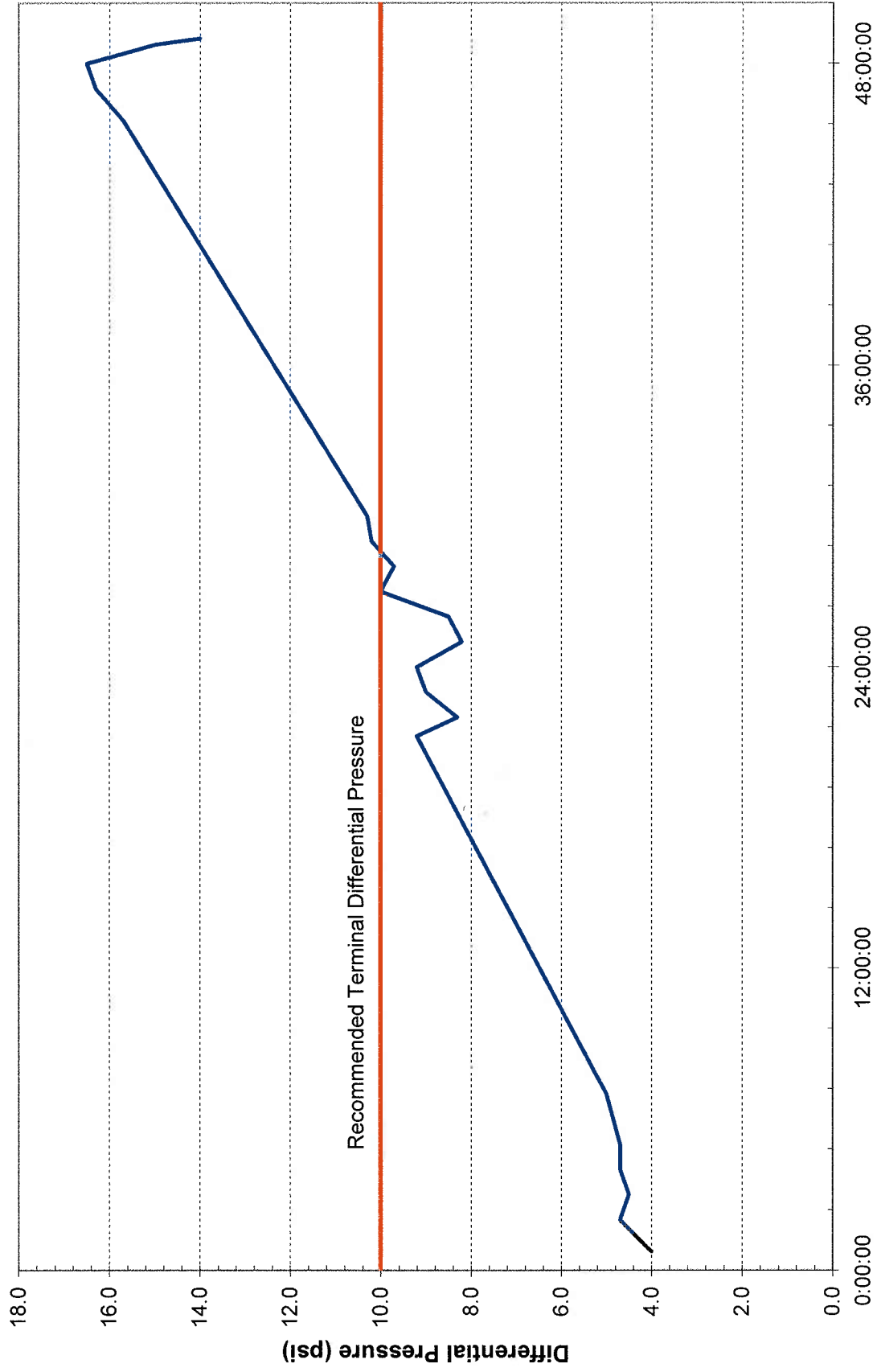
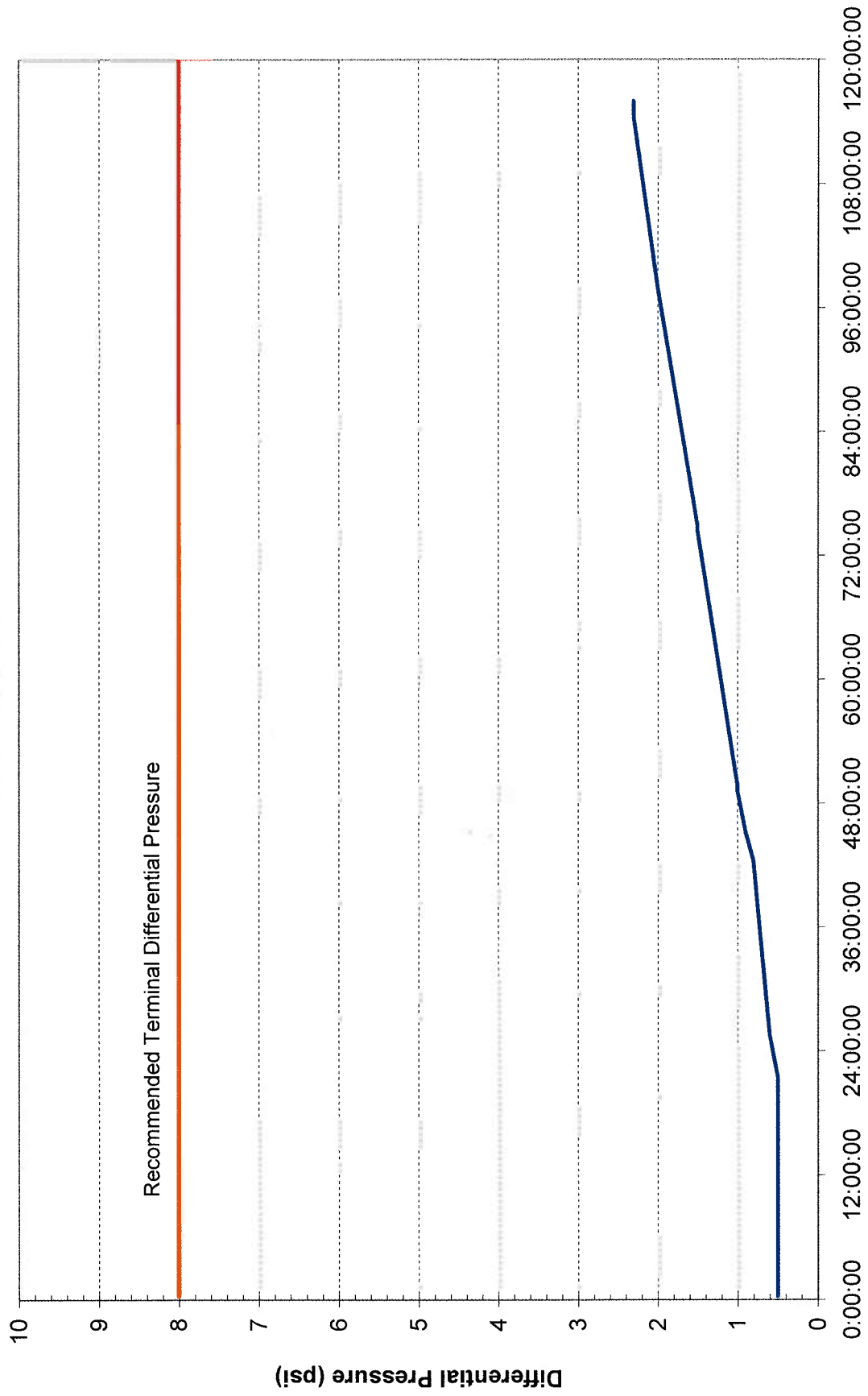

FIGURE 4-20
Dennis Water District
Well No. 20 LayneOx Pilot
Differential Pressure



Run No. 5 (10 gpm/sf)

FIGURE 4-21
Dennis Water District
Well No. 8 GreensandPlus Pilot
Differential Pressure



Run No. 8 (6 gpm/sf)

FIGURE 4-22
Dennis Water District
Well No. 8 LayneOx Pilot
Differential Pressure

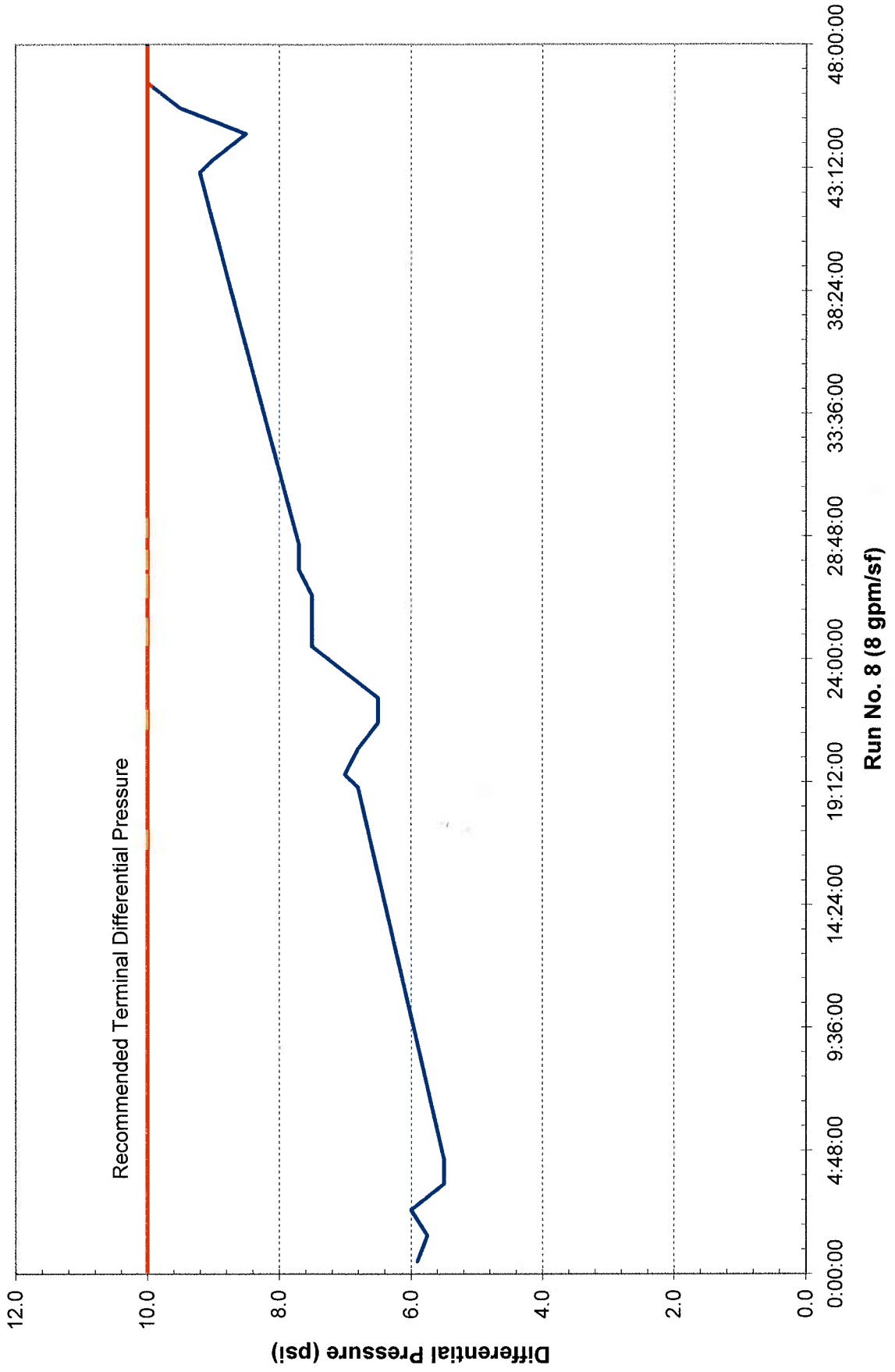

SECTION 5

Summary and Recommendations

5. SUMMARY AND RECOMMENDATIONS

A. SUMMARY

Once optimized, both pilot systems were able to produce their respective water quality treatment objectives by consistently producing finished water with levels less than the SMCLs of 0.3 mg/L of iron (Fe) and 0.05 mg/L of manganese (Mn) under the following conditions:

- GreensandPlus system operated at surface loading rates of 4 and 6 gpm/sf.
- LayneOx system operated at surface loading rates of 6, 8 and 10 gpm/sf.

The chemical doses needed for each process were very similar and complied with theoretical and typical doses of NaOCl and KOH based on the water quality. The optimum chemical doses were as follows based upon the current raw water quality:

- Well No. 20 – GreensandPlus: 1.1 to 1.4 mg/L NaOCl and 32 to 36 mg/L KOH
- Well No. 20 – LayneOx: 1.1 to 1.4 mg/L NaOCl and 32 to 36 mg/L KOH
- Well No. 8 – GreensandPlus: 0.9 to 1.1 mg/L NaOCl and 33 mg/L KOH
- Well No. 8 – LayneOx: 0.9 to 1.1 mg/L NaOCl and 33 mg/L KOH

The residual chlorine in the filter effluent should be maintained at approximately 0.5 mg/L. The target pH in the chemically adjusted water prior to the filter is approximately 7.0 pH units. The doses shown above are the chemicals needed for iron and manganese removal. The District will need to add more KOH to raise the pH to the range needed for corrosion control.

Some of the pilot testing was performed with a simulated raw water transmission main to mimic chemical addition at the existing corrosion control facilities. The additional detention time allowed for removal of iron and manganese that met or exceeded removals achieved without the transmission main. The field data show that utilizing the District's existing corrosion control facilities for addition of chemicals for pH adjustment and oxidation is feasible for final design.

The pilot systems were operated for extended runs to observe whether the runs would be terminated based on differential pressure, water quality or time. The following were observed during the pilot:

- GreensandPlus system extended runs were terminated based on time and an increase in the filter effluent Fe and Mn levels.
- LayneOx system extended runs were terminated based on high differential pressure and an increase in the filter effluent Fe and Mn levels.

By the end of the extended runs, both systems were still producing filtered water with Fe and Mn levels less than the SMCLs but higher than the levels observed earlier in the runs.

The extended runs also provided an opportunity to observe the volume of water treated by each process at the manufacturer recommended higher hydraulic loading rates. The following observations were made:

- GreensandPlus system produced approximately 15% more water than the LayneOx system during the extended run at Well No. 20.
- GreensandPlus system produced approximately 34% more water than the LayneOx system during the extended run at Well No. 8.

The water quality in both wells for the raw and filtered water showed the following:

- No total coliforms were detected.
- No elevated levels of VOCs were detected.
- All metals, except raw water Fe and Mn, were below SMCLs, MCLs and OSRGs.
- Nitrate and fluoride levels were well below the MCLs.
- In summary, all parameters analyzed, except for raw water Fe and Mn, were below SMCLs, MCLs and OSRGs.

B. PRESSURE FILTER SYSTEM DESIGNS

1. Vertical and Horizontal Vessels

This pilot study examined the performance of the GreensandPlus system and LayneOx system in the removal of iron and manganese from groundwater to determine which process is the most advantageous for full scale design. Another key design consideration

is the configuration of the GreensandPlus pressure vessels themselves. They can be aligned either vertically or horizontally. The pressure vessels for the LayneOx system are only available in vertical vessels at this time.

The horizontal pressure vessels are constructed with multiple cells per vessel to minimize the plant footprint and maximize operational flexibility. The vertical pressure vessels are constructed as single celled filter vessels. Both types of vessels are cylindrically shaped. The media surface is rectangular or square for horizontal vessels, whereas it is circular for the vertical vessels. Figure 5-1 shows a typical vertical pressure filter and Figure 5-2 shows a horizontal pressure vessel with three filter cells.

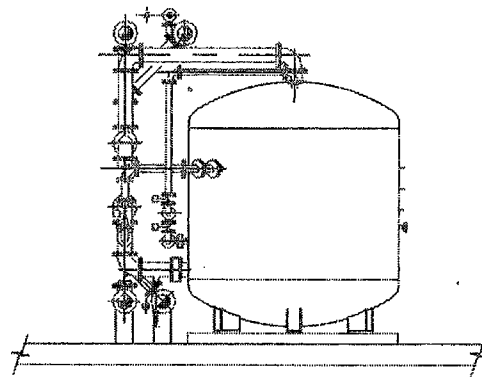

FIGURE 5-1
VERTICAL PRESSURE VESSEL

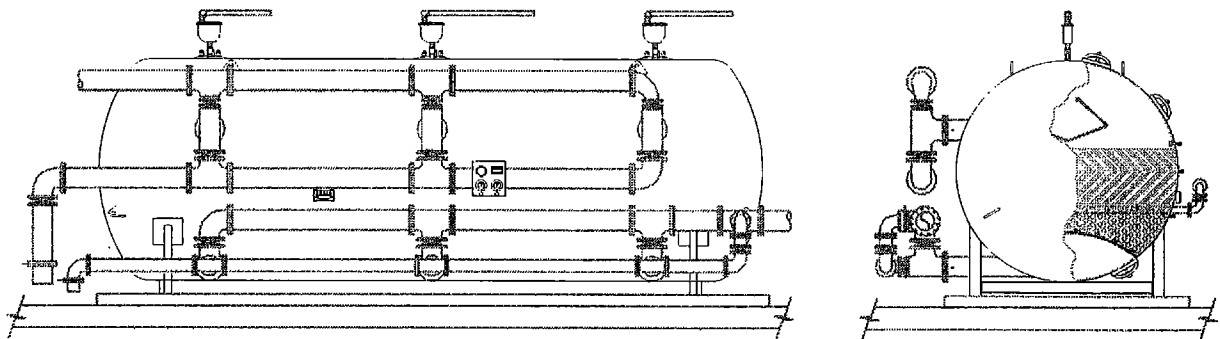

FIGURE 5-2
HORIZONTAL PRESSURE VESSEL WITH 3 FILTER CELLS

The horizontal pressure vessels and associated piping have a smaller footprint than the vertical pressure vessels and they usually require less headroom. The advantages of the vertical pressure vessels are related principally to operations. With vertical vessels, it is much easier and more economical to add on future vertical filters. In addition, the vertical sidewalls produce superior backwashing characteristics.

2. Full Scale Process Design

The full scale systems for both the GreensandPlus system and the LayneOx system could be designed with the following characteristics:

GreensandPlus System

Design flow rate	2,850 gpm
Depth of Anthracite Media.....	18 inches
Depth of GreensandPlus Media.....	19 inches
Depth of Support Gravel	12 inches
Filter service rate at design flow	5 gpm/ft ²
Filter service rate with one filter in backwash.....	6 gpm/ft ²
Filter backwash system	Air/water and water
Filter backwash rate:	
Simultaneous air/water backwash	5 gpm/ft ²
Duration.....	12 minutes
Water only wash (restratification).....	12 gpm/ft ²
Duration.....	3 minutes

If Horizontal Vessels:

Number of Vessels	2
Number of Filter Cells per Vessel.....	3
Surface Area per Filter	100 ft ²
Dimensions of Vessels	10 ft diameter by 30 ft horizontal
Maximum Backwash Flow Rate for One Filter	1,200 gpm
Process Efficiency	99.64%
Annual Backwash Volume (4 mgd non-stop)	5.26 million gallons

If Vertical Vessels:

Number of Vessels	6
Number of Filter Cells per Vessel.....	1
Surface Area per Filter	95 ft ²
Dimensions of Vessels	11 feet diameter
Maximum Backwash Flow Rate for One Filter	1,140 gpm
Process Efficiency	99.66%
Annual Backwash Volume (4 mgd non-stop)	4.99 million gallons

LayneOx System

Design flow rate	2,850 gpm
Depth of LayneOx Media.....	36 inches
Filter service rate at design flow	7.5 gpm/ft ²
Filter service rate with one filter in backwash.....	10 gpm/ft ²
Filter backwash system	Air/water and water
Filter backwash rate:	
Simultaneous air/water backwash	15 gpm/ft ²
Duration.....	10 minutes
Filter configuration.....	Vertical vessels
Number of Vessels	4
Diameter of Vessels.....	11 feet
Surface Area per Filter	95 ft ²
Maximum Backwash Flow Rate for One Filter	1,425 gpm
Process Efficiency	99.29%
Annual Backwash Volume (4 mgd non-stop)	10.4 million gallons

3. Process System Budget Costs

Budget costs were provided by the manufacturers for each 4 mgd filter system. The filter system costs include vessels, media, piping, butterfly valves, pressure gauges, and filter control panel. Note that the cost for the process systems will increase for the use of hydraulically operated globe valves by Cla-Val instead of motor operated butterfly valves. We have projected these costs to represent the cost at the time of bid of the project (June 2008):

GreensandPlus System – Horizontal Vessels.....	\$716,000
(3% inflation on quote from Tonka Equipment Co. received June 2007)	
GreensandPlus System – Vertical Vessels	\$742,000
(3% inflation on quote from Hungerford & Terry received June 2007)	
LayneOx System – Vertical Vessels	\$834,000
(3% inflation on quote from Layne Christensen Co. received June 2007 and added \$50,000 for Air Scour System)	

C. DECISION MATRIX

The following decision matrix presents the factors involved in the selection process. Each factor was rated as 1 = Poor or 2 = Good. The factors were weighted as shown. The Relative Score is the Sum of the Factor Ratings times the Factor Weight. The decision matrix shows that the GreensandPlus system is slightly more favorable than the LayneOx system. We have weighted the factors according to the level of importance we feel should be placed on each.

**TABLE 5-1
DECISION MATRIX**

1 = Poor, 2 = Good

Factor	Factor Weight	GreensandPlus System	LayneOx System
Filtered water meets drinking water standards	10%	2	2
System excels in removing Fe & Mn	10%	2	1
Volume of water treated between backwashes	10%	2	1
Volume of water produced annually	10%	2	1
Higher hydraulic loading rate (smaller footprint)	10%	1	2
Ease of operation and training of staff	10%	2	2
Competitive bidding environment	10%	2	1
Facility capital costs (process & building)	15%	2	2
Operation and maintenance costs	15%	2	2
Relative Score	100%	1.9	1.6

D. DESIGN RECOMMENDATIONS

Earth Tech recommends that the District utilize the GreensandPlus system as the primary treatment process for the full-scale water treatment facilities. The GreensandPlus system performed more favorably during the pilot testing in removal of iron and manganese and produces more water between backwashes due to longer filter run times. Using the pilot data to estimate filter run times of 96 hours for the GreensandPlus system and 48 hours for the LayneOx system, we calculated the process efficiencies. The GreensandPlus system is 0.37% more efficient than the LayneOx system. This translates to a potential savings of 10.8 million gallons per year in backwash supply water (assumes operation at 4 mgd non-stop for two facilities).

In addition to water quality and process efficiency, we examined cost components. The GreensandPlus media can be utilized by several manufacturers of pressure filter systems which allows for more competitive bid prices. The LayneOx media is proprietary and can only be used with the pressure filter system manufactured by Layne Christensen Co. While the higher hydraulic loading rate provided by the LayneOx system allows for a slightly smaller building footprint, the difference in footprint is relatively small and does not significantly impact the overall capital cost of the facility.

SECTION 6

Description of Water Treatment Facilities

6. DESCRIPTION OF WATER TREATMENT FACILITIES

A TREATMENT PLAN

Earth Tech recommends that the full-scale treatment use GreensandPlus filtration as the primary process to produce drinking water meeting the required standards. At this time, the intent is to design and construct two treatment facilities (WTF). Table 6-1 shows the wells to be treated with flow rates. Table 6-2 describes the treatment facility design, maximum and minimum flow rates. Figure 6-1, Proposed Water Treatment Plan, shows the wells to be treated and locates the sites of the proposed water treatment plants.

**TABLE 6-1
WELLS TO RECEIVE TREATMENT**

North Side WTF		South Side WTF	
Well	Flow (gpm)	Well	Flow (gpm)
Well No. 4	300	Well No. 7	700
Well No. 9	600	Well No. 8	300
Well No. 11	550	Well No. 15	700
Well No. 19	700	Well No. 16	450
Well No. 20	700	Well No. 21	700
North Side WTF	2,850	South Side WTF	2,850

**TABLE 6-2
DESCRIPTION OF TREATMENT FACILITIES**

WTF	Design Flow		Maximum Flow		Minimum Flow	
	(gpm)	(MGD)	(gpm)	(MGD)	(gpm)	(MGD)
North Side	2,850	4.1	2,850	4.1	300	0.43
South Side	2,850	4.1	2,850	4.1	300	0.43

Proposed Water Treatment Plan

Dennis Water District

- Water District Land
- Well Requiring Treatment
- North Side Supply
- Existing Corrosion Control Facility
- Proposed Water Treatment Plant
- Proposed Raw Water Line (Existing)
- Proposed Raw Water Line (New)

- Iron and Manganese (2 or more exceedances of SMCL within past 5 years)
- Manganese (2 or more exceedances of SMCL within past 5 years)
- Minimal Iron or Manganese (Less than 2 exceedances of SMCL within past 5 years)

- Pipe Size
- 6"
- 8"
- 10"
- 12"
- 16"
- 24"

- 1"
- 1-1/2"
- 2"
- 2-1/2"
- 4"

EarthTech
A Harsco International UK Company

0 300 600 1,200
Feet

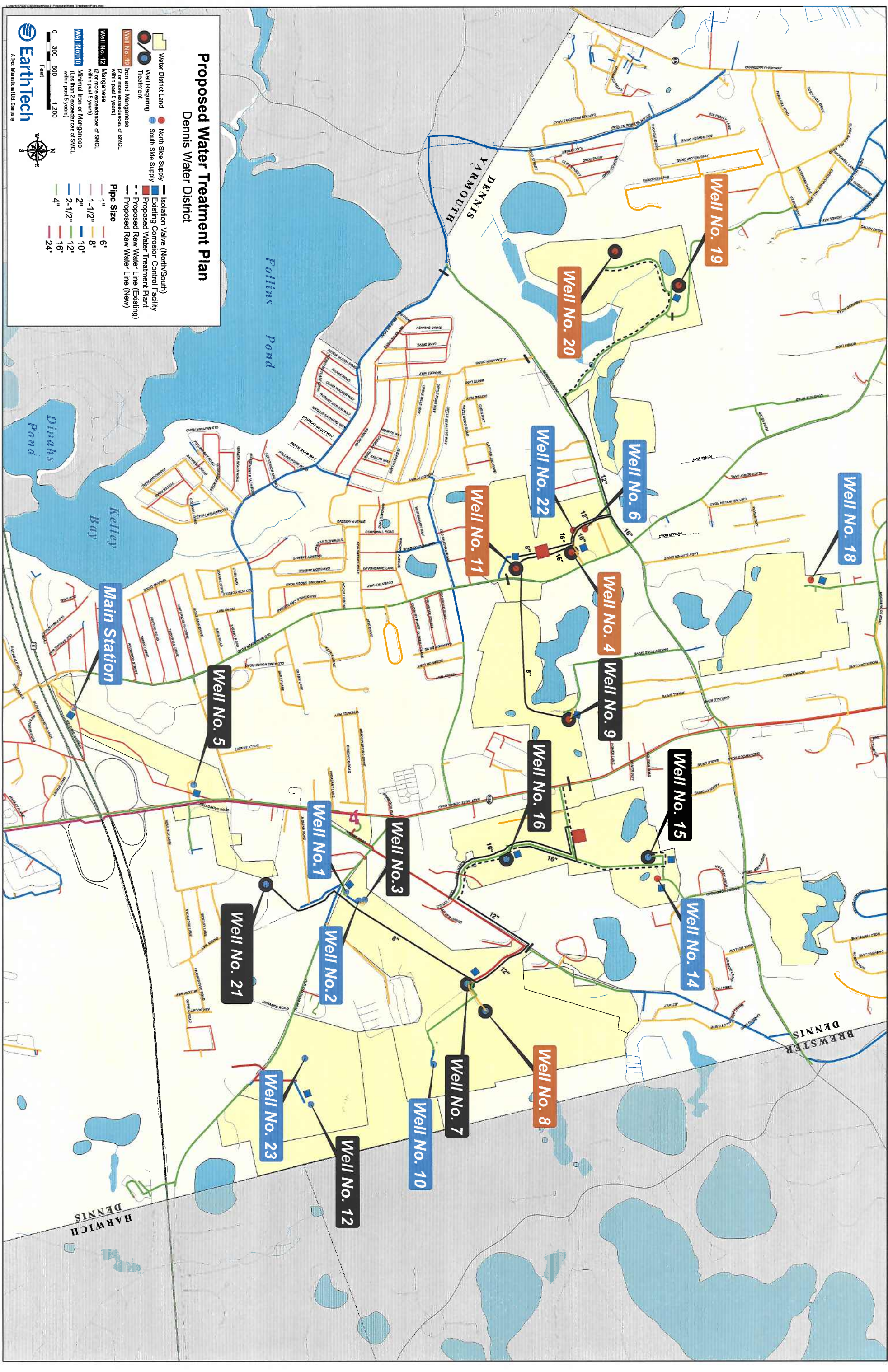

B. DESCRIPTION OF FACILITIES

The primary treatment process for the two water treatment facilities utilizes GreensandPlus media for iron and manganese removal. Figure 6-2, located at the end of this Section, shows the proposed floor plan of the water treatment facilities. At this time, it is anticipated that the two water treatment facilities will be the same capacity and footprint, but have customized site designs.

1. Backwash Supply from On-Site Basin versus Distribution System

The District's groundwater quality and the pressure filter system technology examined as part of this pilot do not require the use of a clearwell for disinfection log removal. Therefore, the District opted for a pump-thru system design. The pump-thru system eliminates the need for a clearwell and the associated finished water pumps. The well pumps will need to be modified to account for the additional headloss through the water treatment facility. Backwash supply can be obtained from an on-site basin or directly from the distribution system for pressure filtration systems. Using water from the distribution system for backwash eliminates the need for on-site storage and backwash pumps. It is necessary to confirm that the quantity of flow and volume is available and will not be disruptive to the distribution system hydraulics or water quality. Backwash supply basins require the construction of on-site storage, potentially below the facility floor, which is an added capital cost. This method also requires the use of backwash supply pumps adding to the capital and operation and maintenance costs.

The proposed locations of the water treatment facilities are sited in areas with large diameter water main nearby. The maximum backwash flow rate for one filter is estimated to be 1,200 gpm. After reviewing the advantages and disadvantages of each method, the District opted to obtain backwash supply from the distribution system. This method uses the pump-thru design and allows for a slab-on-grade construction providing a significant savings in cost.

2. Disposal of Backwash Residuals

The sites for the proposed water treatment facilities have space to allow for the use of on-site lagoons for handling of the backwash residuals. Backwash residuals would be discharged to the lagoons where the iron and manganese solids would settle and collect at the bottom of the lagoon and the clarified supernatant would percolate into the ground. Over time the iron and manganese solids collecting at the bottom of the lagoon would form a solids "cake" which would be periodically removed and disposed of legally.

The MassDEP is developing a new policy entitled "Permit Requirements for the Disposal of Water Treatment Plant Residuals to Lagoon Systems." This policy is currently available in draft form and the MassDEP is requiring new water treatment facilities to comply with the policy. Essentially, the policy states that a Groundwater Discharge Permit is required for new water treatment facilities using unlined lagoons for handling of process residuals (Option 1). To avoid the requirement to submit a Groundwater Discharge Permit, the facility could be constructed with two lined lagoons for solids settling with the supernatant discharging to a third unlined lagoon for percolation into the ground (Option 2). With this design, the groundwater standards would be considered as met and a permit would not be required.

Option 1 (Unlined Lagoons) offers advantages including a smaller footprint and lower lagoon construction costs. However, the District would have additional costs associated with submittal of and ongoing compliance with the Groundwater Discharge Permit including construction of groundwater monitoring wells and periodic monitoring of water quality. We recommend that the District examine the options during the design phase of the water treatment facilities to determine which option is the most advantageous.

3. Design Criteria

The following is a summary of design criteria for the water treatment facilities:

PROCESS EQUIPMENT

GreensandPlus System

Design flow rate	2,850 gpm
Filter configuration.....	Vertical vessels
Number of Vessels	6
Number of Filter Cells per Vessel	1
Surface Area per Filter Cell.....	95 ft ²
Dimension of Vessels.....	11 ft diameter
Depth of Anthracite Media.....	18 inches
Depth of GreensandPlus Media.....	19 inches
Depth of Support Gravel	12 inches
Filter service rate at design flow	5 gpm/ft ²
Filter service rate with one filter in backwash.....	6 gpm/ft ²
Filter backwash system	Air/water and water
Filter backwash rate:	
Simultaneous air/water backwash	5 gpm/ft ²
Duration.....	12 minutes
Water only wash (restratification).....	12 gpm/ft ²
Duration.....	3 minutes
Filter vessel material	Painted steel
Piping (Water).....	Ductile iron
Piping (Air)	Stainless Steel
Filter control valves.....	Hydraulically operated (Cla-Val)
Flow meters	Magnetic flow meters
Filter control panel	PLC with OIT

Process Piping & Valves

Raw and finished water	Ductile iron
Chemical transfer and feed.....	Schedule 80 PVC and CPVC
Isolation valves.....	Butterfly valves
Flow control valves	Cla-Val
Chemical feed.....	Ball valves

Chemical Pumping Equipment

Oxidation of Iron (Injected at Corrosion Control Facility)

Chemical.....	Sodium hypochlorite (12.5% solution)
Number of feed pumps	1 plus 1 spare
Application point.....	Raw water
Design dosage.....	1.0 mg/L dry (range of 0.8 to 1.5 mg/L dry)
Number of transfer pumps.....	1 per chemical

Disinfection (Injected at Water Treatment Facility)

Chemical..... Sodium hypochlorite (12.5% solution)
Number of feed pumps1 plus 1 spare
Application point..... Finished water
Design dosage.....0.5 mg/L dry
Number of transfer pumps..... 1 per chemical

Pre-filter pH Adjustment (Injected at Corrosion Control Facility)

Chemical..... Potassium hydroxide (45% solution)
Number of feed pumps1 plus 1 spare
Application point..... Raw water
Design dosage..... 35 mg/L dry (range of 20 to 40 mg/L dry)
Number of transfer pumps..... 1 per chemical

Post pH Adjustment (Injected at Water Treatment Facility)

Chemical..... Potassium hydroxide (45% solution)
Number of feed pumps1 plus 1 spare
Application point..... Finished water
Design dosage..... 10 mg/L dry (range of 5 to 20 mg/L dry)
Number of transfer pumps..... 1 per chemical

Chemical Storage

Sodium Hypochlorite (Post Adjustment Only - Storage at Water Treatment Facility)

Number of bulk tanks 1
Bulk tank volume 400 gallons
Number of days storage..... 30 days
Post day tank volume 25 gallons
Materials of construction..... Polyethylene (HDPE)

Potassium Hydroxide (Post Adjustment Only - Storage at Water Treatment Facility)

Number of bulk tanks 1
Bulk tank volume 3,000 gallons
Number of days storage..... 30 days
Post day tank volume 100 gallons
Materials of construction..... Polyethylene

Backwash Supply

Type..... Backwash supply from distribution system
Design flow rate for each filter.....500 to 1,200 gpm

Well Pumps Modifications

Number of pumps.....10

Backwash Residuals Handling - On-Site Lagoons

Number of Lagoons.....3
Total Depth.....6 feet
Bed Area..... 1,000 sf

STRUCTURE

Foundation.....	Slab-on-grade
Superstructure.....	Pre-engineered metal building
Roof.....	Standing seam metal roof
Building Dimensions.....	45 feet by 85 feet
Building Area	3,825 sf

TRANSMISSION MAINS (CHEMICAL ADJUSTED WATER)

North Side

8-inch Diameter.....	3,400 l.f.
12-inch Diameter.....	5,150 l.f.
16-inch Diameter.....	400 l.f.

South Side

8-inch Diameter.....	2,550 l.f.
12-inch Diameter.....	4,600 l.f.
16-inch Diameter.....	1,850 l.f.

C. ESTIMATED CAPITAL AND O&M COSTS

Our estimates of probable project cost are for planning purposes only and should be re-evaluated prior to appropriating funds for the actual construction of each project. The engineering, construction and operational cost are based on individual site-specific projects. The ENR construction cost index at the time of this budget cost estimate was 7939 for June 2007. The opinion of probable construction costs are shown in the following Table 6-3.

**TABLE 6-3
OPINION OF PROBABLE CONSTRUCTION COSTS**

Item	Description	Cost
North Side WTP	WTP Construction	\$ 3,500,000
	Water Main Construction	\$ 900,000
	Subtotal - Construction	\$ 4,400,000
South Side WTP	WTP Construction	\$ 3,500,000
	Water Main Construction	\$ 1,100,000
	Subtotal - Construction	\$ 4,600,000
Contingency	20% of Construction Estimate	\$ 1,800,000
Engineering	Design/Bidding/Construction	\$ 1,100,000
Total		\$ 11,900,000

Assumptions:

Land already owned by District - no land acquisition costs included.

Water main costs assume public bidding is not required and construction is by the District.

Costs projected to 2008, assuming 3% inflation rate.

The additional operation and maintenance costs include the following:

- Chemical cost for sodium hypochlorite only (the District currently uses potassium hydroxide for pH adjustment),
- Labor,
- Electricity for additional pumping through the process,
- Media replacement.

Table 6-4 shows the estimated additional operation and maintenance costs.

TABLE 6-4
ESTIMATED ADDITIONAL OPERATION AND MAINTENANCE COSTS

Description	Cost	Frequency
Labor (1 operator)	\$80,000	per year
Electricity (\$0.22 per kwh)	\$180,000	per year
Chemicals	\$50,000	per year
Media Replacement	\$200,000	every 10 years

Assumptions:

Costs shown are additional to those the District already experiences.

Costs for 16 hours per day operation at 4 mgd.

Costs based on two water treatment facilities.

Labor cost includes fringe benefits.

Chemical costs for sodium hypochlorite only.

Media cost is materials only (no labor or disposal costs).

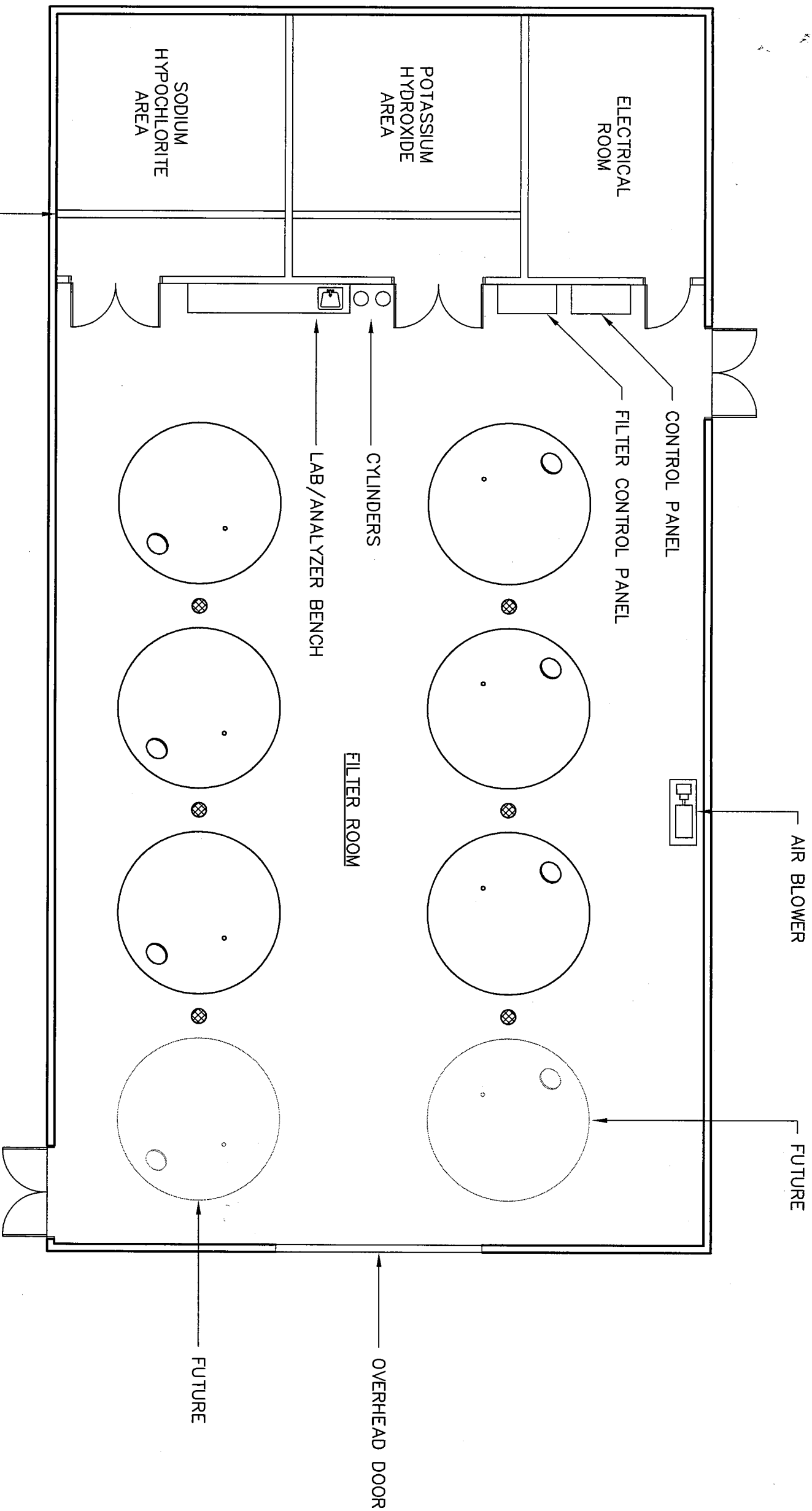

FLOOR PLAN
SCALE: 1/8"=1'-0"